

Practicalities of machine learning: applications to high-throughput genomics with Bioconductor MLInterfaces 2.2

VJ Carey

December 16, 2009

Contents

1	Overview	2
2	Getting acquainted with machine learning via the crabs data	3
2.1	Attaching and checking the data	3
2.2	A simple classifier derived by human reasoning	4
2.3	Prediction via logistic regression	4
2.4	The cross-validation concept	5
2.5	Exploratory multivariate analysis	7
2.5.1	Scatterplots	7
2.5.2	Principal components; biplot	8
2.5.3	Clustering	10
2.6	Supervised learning	14
2.6.1	RPART	14
2.6.2	Random forests	16
2.6.3	Linear discriminants	17
2.6.4	Neural net	18
2.6.5	SVM	20
3	Learning with expression arrays	21
3.1	Phenotype reduction	21
3.2	Nonspecific filtering	21
3.3	Exploratory work	22
3.4	Classifier construction	25
3.4.1	Demonstrations	25
3.4.2	Gene set appraisal	28

4	Embedding features selection in cross-validation	29
5	Learning with array CGH	30

1 Overview

The term *machine learning* refers to a family of computational methods for analyzing multivariate datasets. Each data point has a vector of *features* in a shared *feature space*, and may have a *class label* from some fixed finite set.

Supervised learning refers to processes that help articulate rules that map *feature vectors* to *class labels*. The class labels are known and function as supervisory information to guide rule construction. *Unsupervised learning* refers to processes that discover structure in collections of feature vectors. Typically the structure consists of a grouping of objects into clusters.

This practical introduction to machine learning will begin with a survey of a low-dimensional dataset to fix concepts, and will then address problems coming from expression arrays and array CGH data.

Some basic points to consider at the start:

- Distinguish predictive modeling from inference on model parameters. Typical work in epidemiology focuses on estimation of relative risks, and random samples are not required. Typical work with machine learning tools targets estimation (and minimization) of the misclassification rate. Representative samples are required for this task.
- “Two cultures”: model fitters vs. algorithmic predictors. If statistical models are correct, parameter estimation based on the mass of data can yield optimal discriminators (e.g., LDA). Algorithmic discriminators tend to prefer to identify boundary cases and downweight the mass of data (e.g., boosting, svm).
- Different learning tools have different capabilities. There is little *a priori* guidance on matching learning algorithms to aspects of problems. While it is convenient to shift through a variety of approaches, one must pay a price for the model search.
- Data and model/learner visualization are important, but visualization in higher dimensional data structures is hard. Dynamic graphics can help; look at ggobi and Rggobi for this.
- These notes provide very little mathematical background on the methods; see for example Ripley (*Pattern recognition and neural networks*, 1995), Duda, Hart, Stork (*Pattern classification*), Hastie, Tibshirani and Friedman (2003, *Elements of statistical learning*) for copious background.

2 Getting acquainted with machine learning via the crabs data

2.1 Attaching and checking the data

The following steps bring the crabs data into scope and illustrate aspects of its structure.

```
> library(MASS)
> data(crabs)
> dim(crabs)

[1] 200  8

> crabs[1:4, ]

  sp sex index  FL  RW  CL  CW  BD
1  B  M     1 8.1 6.7 16.1 19.0 7.0
2  B  M     2 8.8 7.7 18.1 20.8 7.4
3  B  M     3 9.2 7.8 19.0 22.4 7.7
4  B  M     4 9.6 7.9 20.1 23.1 8.2

> table(crabs$sex)

  F  M
100 100

> library(lattice)
> print(bwplot(RW ~ sp | sex, data = crabs))
```

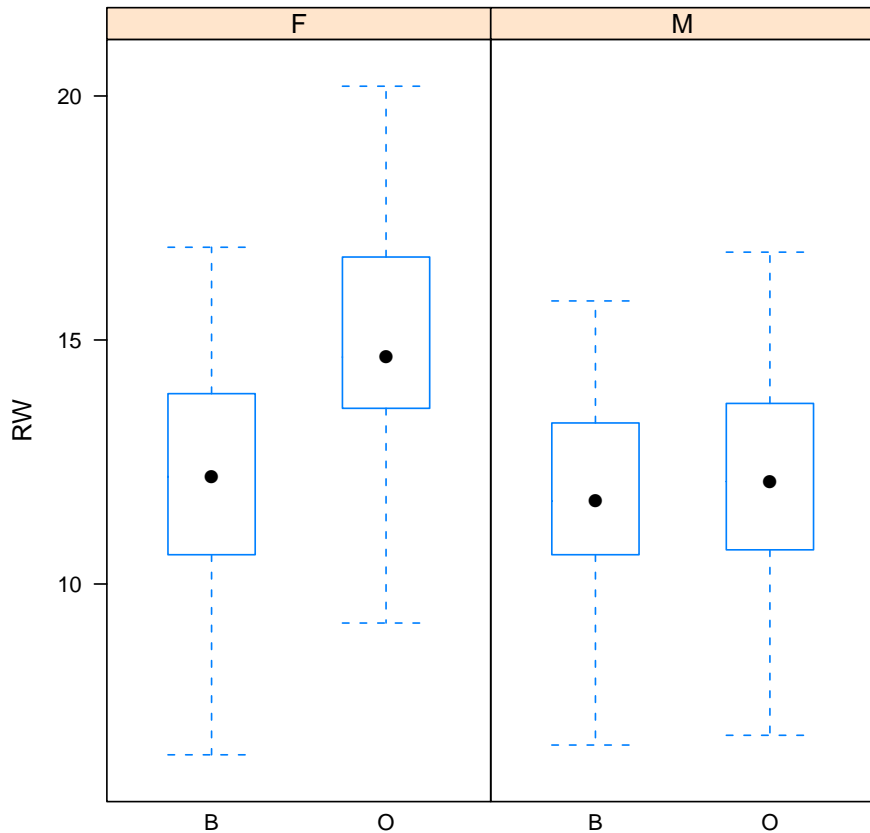

We will regard these data as providing five features (FL, RW, CL, CW, BD) and a pair of class labels (sex, sp=species). We may regard this as a four class problem, or as two two class problems.

2.2 A simple classifier derived by human reasoning

Our first problem does not involve any computations. If you want to write R code to solve the problem, do so, but use prose first.

- *Question 1.* On the basis of the lattice plot given above, comment on the prospects for predicting species on the basis of RW. State a rule for computing the predictions. Describe how to assess the performance of your rule.

2.3 Prediction via logistic regression

A simple approach to prediction involves logistic regression.

```
> m1 = glm(sp ~ RW, data = crabs, fam = binomial)
> summary(m1)
```

```
Call:
glm(formula = sp ~ RW, family = binomial, data = crabs)
```

```
Deviance Residuals:
```

Min	1Q	Median	3Q	Max
-1.67807	-1.08840	-0.04168	1.07160	1.88030

```
Coefficients:
```

	Estimate	Std. Error	z value	Pr(> z)
(Intercept)	-3.44908	0.82210	-4.195	2.72e-05 ***
RW	0.27080	0.06349	4.265	2.00e-05 ***

```
---
```

```
Signif. codes:  0 '***' 0.001 '**' 0.01 '*' 0.05 '.' 0.1 ' ' 1
```

```
(Dispersion parameter for binomial family taken to be 1)
```

```
Null deviance: 277.26 on 199 degrees of freedom
Residual deviance: 256.35 on 198 degrees of freedom
AIC: 260.35
```

```
Number of Fisher Scoring iterations: 4
```

- *Question 2.* Write down the statistical model corresponding to the R expression above. How can we derive a classifier from this model?
- *Question 3.* Perform the following computations. Discuss their interpretation. What are the estimated error rates of the two models? Is the second model better?

```
> table(predict(m1, type = "response") > 0.5, crabs$sp)
> m2 = update(m1, subset = sex == "F")
> table(predict(m2, type = "response") > 0.5, crabs$sp[crabs$sex ==
+ "F"])
```

2.4 The cross-validation concept

Cross-validation is a technique that is widely used for reducing bias in estimation of predictive accuracy. Briefly, the dataset is deterministically partitioned into a series of training and test sets. The model is built for each training set and evaluated on the test set. The accuracy measures are averaged over this series of fits. Leave-one-out cross-validation consists of N fits, with N training sets of size $N-1$ and N test sets of size 1.

First let's use `MLearn` from the `MLInterfaces` package to fit a single logistic model. `MLearn` requires you to specify a training index set. We use `c(1:30, 51:80)` to choose

a training set of size 60, balanced between two species (because we know the ordering of records). This procedure also requires you to specify a probability threshold for classification. We use a typical default of 0.5. If the predicted probability of being "O" exceeds 0.5, we classify to "O", otherwise to "B".

```
> library(MLInterfaces)
> fcrabs = crabs[crabs$sex == "F", ]
> m11 = MLearn(sp ~ RW, fcrabs, glmI.logistic(thresh = 0.5), c(1:30,
+      51:80), family = binomial)
> m11
```

MLInterfaces classification output container

The call was:

```
MLearn(formula = sp ~ RW, data = fcrabs, .method = glmI.logistic(thresh = 0.5),
      trainInd = c(1:30, 51:80), family = binomial)
```

Predicted outcome distribution for test set:

```
0
40
```

Summary of scores on test set (use testScores() method for details):

Min.	1st Qu.	Median	Mean	3rd Qu.	Max.
0.7553	0.8861	0.9803	0.9355	0.9917	0.9997

```
> confuMat(m11)
```

```
      predicted
given 0
      B 20
      O 20
```

- *Question 4.* What does the report on m11 tell you about predictions with this model? Can you reconcile this with the results in model m2? [Hint – non-randomness of the selection of the training set is a problem.]
- *Question 5.* Modify the MLearn call to obtain a predictor that is more successful on the test set.

Now we will illustrate cross-validation. First, we scramble the order of records in the ExpressionSet so that sequentially formed groups are approximately random samples.

```
> set.seed(123)
> sfcrabs = fcrabs[sample(1:100, size = 100, replace = FALSE),
+ ]
```

We invoke the MLearn method in two ways – first specifying a training index set, then specifying a five-fold cross-validation.

```
> sml1 = MLearn(sp ~ RW, sfcraBS, glmI.logistic(thresh = 0.5),
+   c(1:30, 51:80), family = binomial)
> confuMat(sml1)
```

```
      predicted
given B  0
      B 13 10
      0  3 14
```

```
> smx1 = MLearn(sp ~ RW, sfcraBS, glmI.logistic(thresh = 0.5),
+   xvalSpec("LOG", 5, function(data, clab, iternum) {
+     which(rep(1:5, each = 20) == iternum)
+   }), family = binomial)
> confuMat(smx1)
```

```
      predicted
given B  0
      B 34 16
      0 12 38
```

- *Question 6.* Define clearly the difference between models sml1 and smx1 and state the misclassification rate estimates associated with each model.

2.5 Exploratory multivariate analysis

2.5.1 Scatterplots

- *Question 7.* Interpret the following code. Modify it to depict the pairwise configurations with different colors for crab genders.

```
> pairs(crabs[, -c(1:3)], col = ifelse(crabs$sp == "B", "blue",
+   "orange"))
```

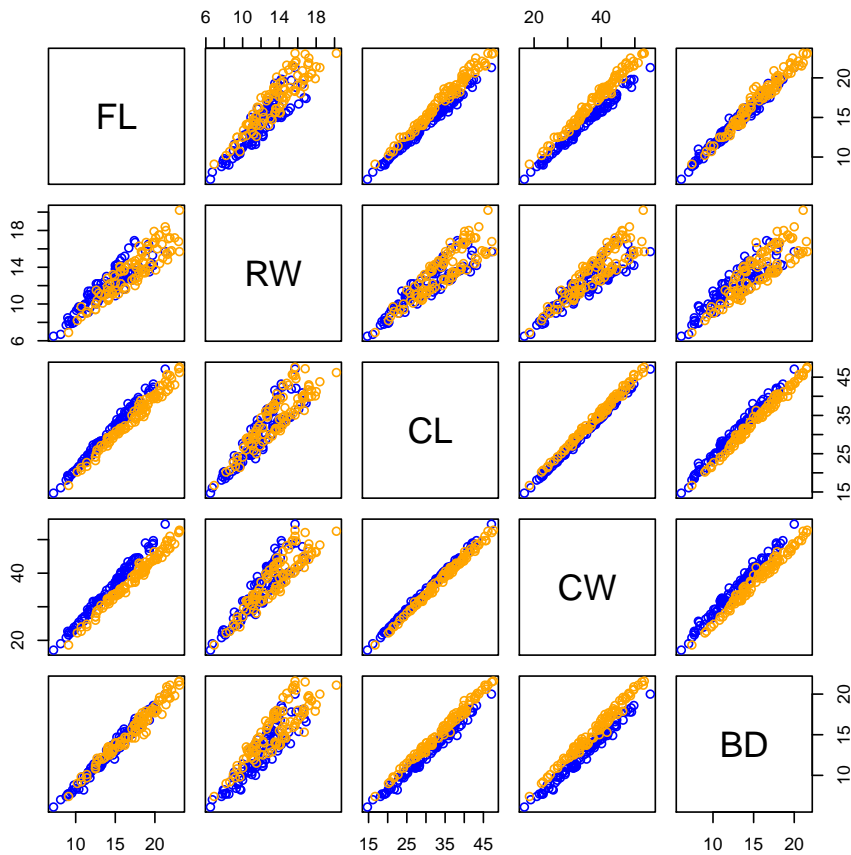

2.5.2 Principal components; biplot

Principal components analysis transforms the multivariate data X into a new coordinate system. If the original variables are X_1, \dots, X_p , then the variables in the new representation are denoted PC_1, \dots, PC_p . These new variables have the properties that PC_1 is the linear combination of the X having maximal variance, PC_2 is the variance-maximizing linear combination of residuals of X after projecting on PC_1 , and so on. If most of the variation in $X_{n \times p}$ can be captured in a low dimensional linear subspace of the space spanned by the columns of X , scatterplots of the first few principal components will depict this.

Formally, we can compute the PC using the singular value decomposition of X , in which $X = UDV^t$, where $U_{n \times p}$ and $V_{p \times p}$ are orthonormal, and D is a diagonal matrix of p nonnegative singular values. The principal components transformation is $XV = UD$, and if D is structured so that $D_{ii} \geq D_{jj}$ whenever $i > j$, then column i of XV is PC_i . Note also that $D_{ii} = \sqrt{n - 1} \text{SD } PC_i$.

```
> pc1 = prcomp(crabs[, -c(1:3)])
```



```
> pairs(pc1$x, col = ifelse(crabs$sp == "B", "blue", "orange"))
```

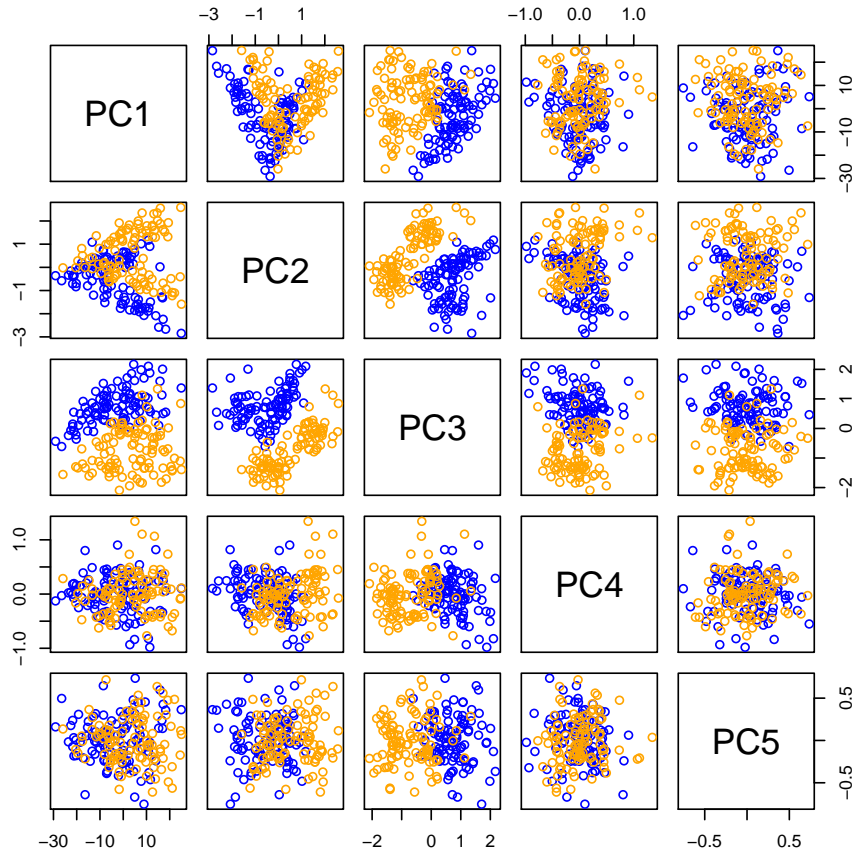

The biplot shows the data in PC space and also shows the relative contributions of the original variables in composing the transformation.

```
> biplot(pc1, choices = 2:3)
```

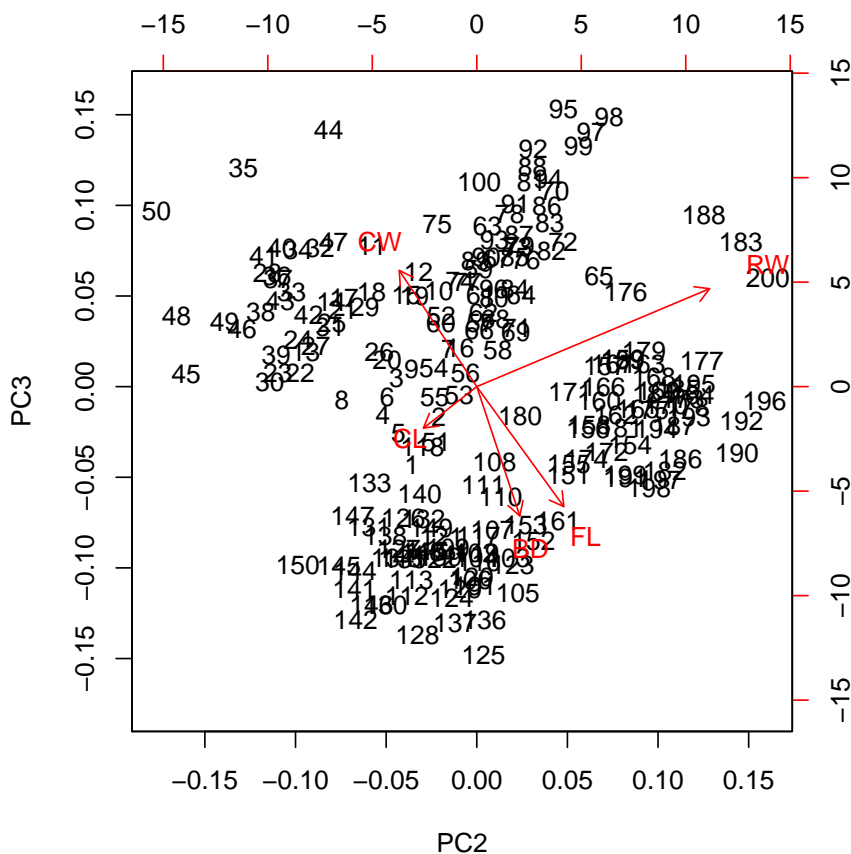

2.5.3 Clustering

A familiar technique for displaying multivariate data in high-throughput biology is called the heatmap. In this display, samples are clustered as columns, and features as rows. The clustering technique used by default is R 'hclust'. This procedure builds a clustering tree for the data as follows. Distances are computed between feature vectors for all N observations. The two closest observations are joined and are regarded as a new object, so there are $N - 1$ objects (clusters) at this point. This process is repeated until 1 cluster is formed; the clustering tree shows the process by which clusters are created via agglomeration.

There are several ways to measure distances between clusters, once these have been formed. Single-linkage clustering takes the distance between two clusters to be the shortest distance between any two members of the different clusters; average linkage averages all the distances between members; complete-linkage uses the maximum distance between any two members of the different clusters. Other methods are available in hclust.

The following figure shows cluster trees for samples and features, using all defaults for the heatmap function. A tiled display at the top shows the species codes for the

samples.

```
> X = data.matrix(crabs[, -c(1:3)])  
> heatmap(t(X), ColSideColors = ifelse(crabs$sp == "O", "orange",  
+   "blue"))
```

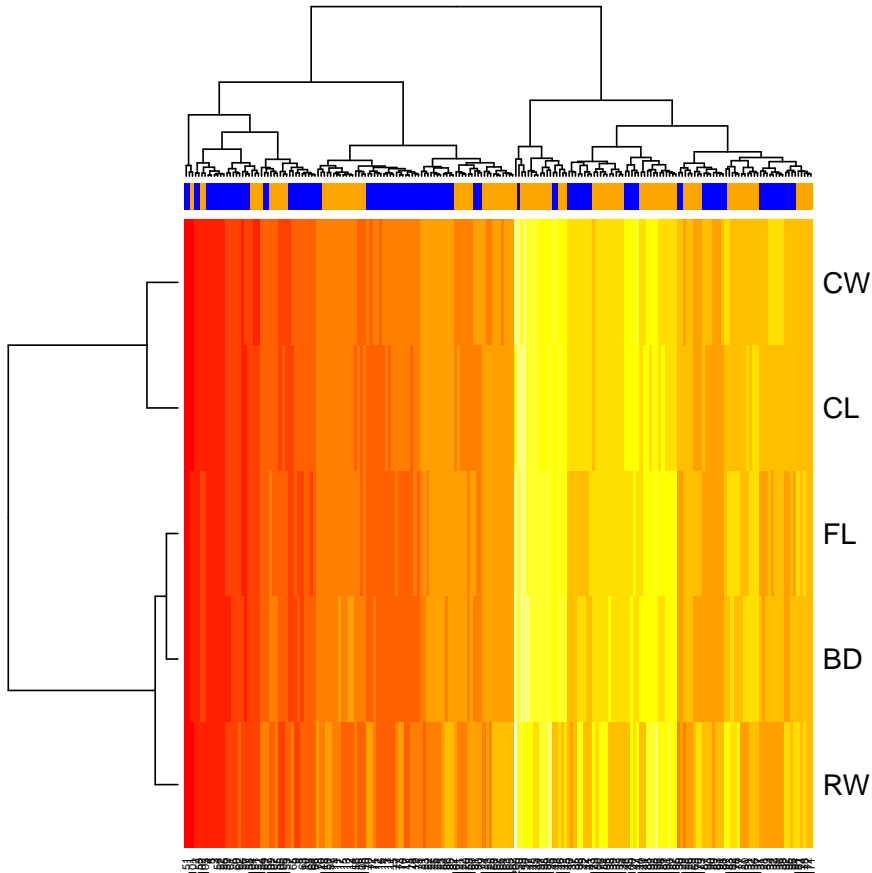

Typically clustering is done in the absence of labels – it is an example of unsupervised machine learning. We can ask whether the clustering provided is a 'good' one using the measurement of a quantity called the *silhouette*. This is defined in R documentation as follows:

For each observation i , the `_silhouette width_` $s(i)$ is defined as follows:

Put $a(i)$ = average dissimilarity between i and all other points of the cluster to which i belongs (if i is the `_only_` observation in its cluster, $s(i) := 0$ without further calculations). For all `_other_` clusters C , put $d(i,C)$ = average dissimilarity of i to all observations of C . The smallest of these $d(i,C)$ is $b(i) := \min_C$

$d(i,C)$, and can be seen as the dissimilarity between i and its "neighbor" cluster, i.e., the nearest one to which it does *not* belong. Finally,

$$s(i) := (b(i) - a(i)) / \max(a(i), b(i)).$$

We can compute the silhouette for any partition of a dataset, and can use the hierarchical clustering result to define a partition as follows:

```
> cl = hclust(dist(X))
> tr = cutree(cl, 2)
> table(tr)
```

```
tr
 1  2
105 95
```

```
> library(cluster)
> sil = silhouette(tr, dist(X))
> plot(sil)
```

Silhouette plot of (x = tr, dist = dist(X))

n = 200

2 clusters C_j

$j: n_j \mid \text{ave}_{i \in C_j} s_i$

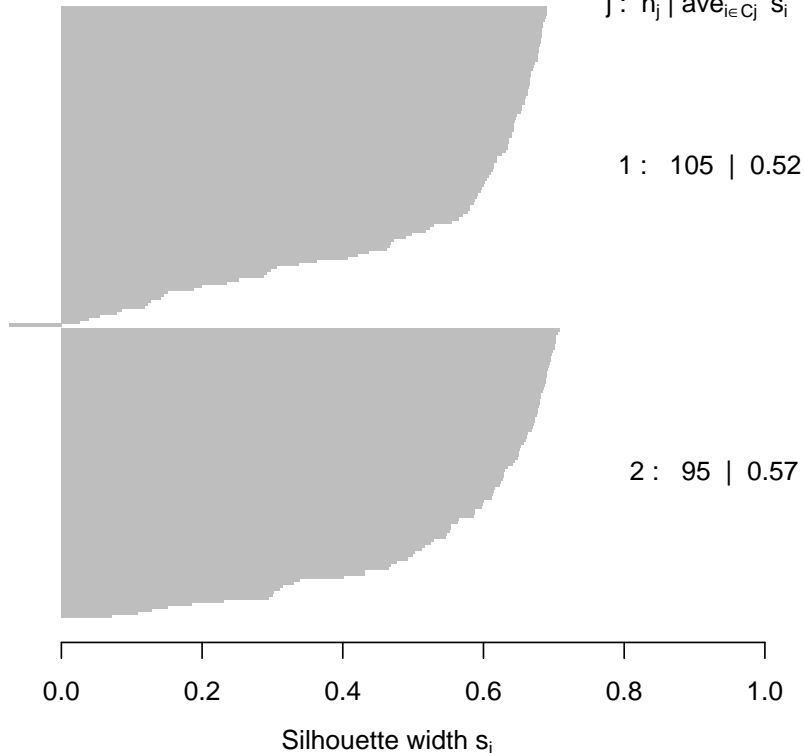

Average silhouette width : 0.55

- *Question 8.* In the preceding, we have used default `dist`, and default clustering algorithm for the heatmap. Investigate the impact of altering the choice of distance and clustering method on the clustering performance, both in relation to capacity to recover groups defined by species and in relation to the silhouette distribution.
- *Question 9.* The PCA shows that the data configuration in PC2 and PC3 is at least bifurcated. Apply hierarchical and K-means clustering to the two-dimensional data in this subspace, and compare results with respect to capturing the species \times gender labels, and with respect to silhouette values. For example, load the `exprs` slot of `crES` [see just below for the definition of this structure] with the PCA reexpression of the features, call the result `pcrES`, and then:

```
> ff = kmeansB(pcrES[2:3,], k=4)
> table(ff@clustIndices, crES$spsex)
```

2.6 Supervised learning

In this section we will examine procedures for polychotomous prediction. We want to be able to use the measurements to predict both species and sex of the crab. Again we would like to use the MLInterfaces infrastructure, so an ExpressionSet container will be useful.

```
> feat2 = t(data.matrix(crabs[, -c(1:3)]))
> pd2 = new("AnnotatedDataFrame", crabs[, 1:2])
> crES = new("ExpressionSet", exprs = feat2, phenoData = pd2)
> crES$spsex = paste(crES$sp, crES$sex, sep = ":")
> table(crES$spsex)
```

```
B:F B:M O:F O:M
 50  50  50  50
```

We will permute the samples so that simple selections for training set indices are random samples.

```
> set.seed(1234)
> crES = crES[, sample(1:200, size = 200, replace = FALSE)]
```

2.6.1 RPART

A classic procedure is recursive partitioning.

```
> library(rpart)
> tr1 = MLearn(spsex ~ ., crES, rpartI, 1:140)
> tr1
```

MLInterfaces classification output container

The call was:

```
MLearn(formula = spsex ~ ., data = crES, .method = rpartI, trainInd = 1:140)
```

Predicted outcome distribution for test set:

```
B:F B:M O:F O:M
 17  11  16  16
```

Summary of scores on test set (use testScores() method for details):

```
      B:F      B:M      O:F      O:M
0.3013154 0.2050270 0.2892524 0.2044052
```

```
> confuMat(tr1)
```

```

predicted
given B:F B:M O:F O:M
B:F  10   4   3   0
B:M   2   4   0   4
O:F   3   1  11   3
O:M   2   2   2   9

```

The actual tree is

```

> plot(RObject(tr1))
> text(RObject(tr1))

```

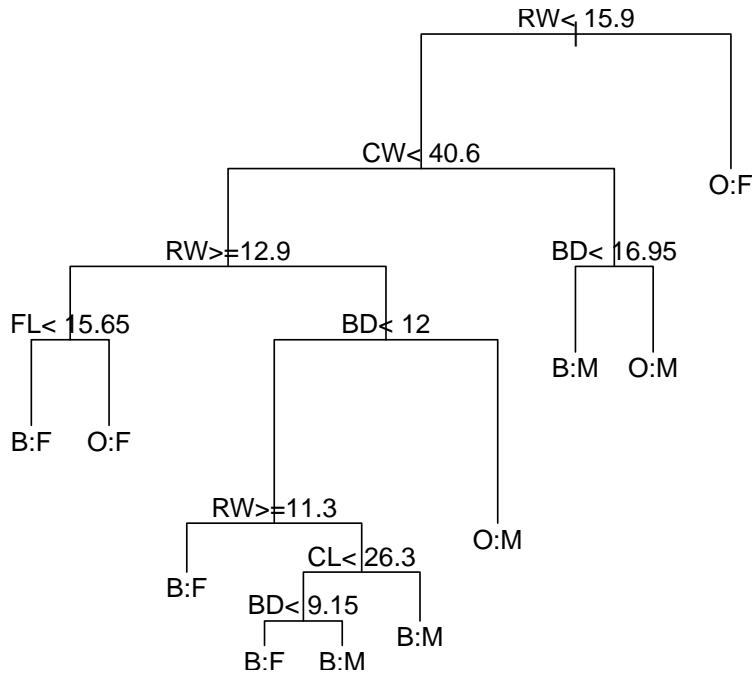

This procedure includes a diagnostic tool called the cost-complexity plot:

```

> plotcp(RObject(tr1))

```

This procedure in-

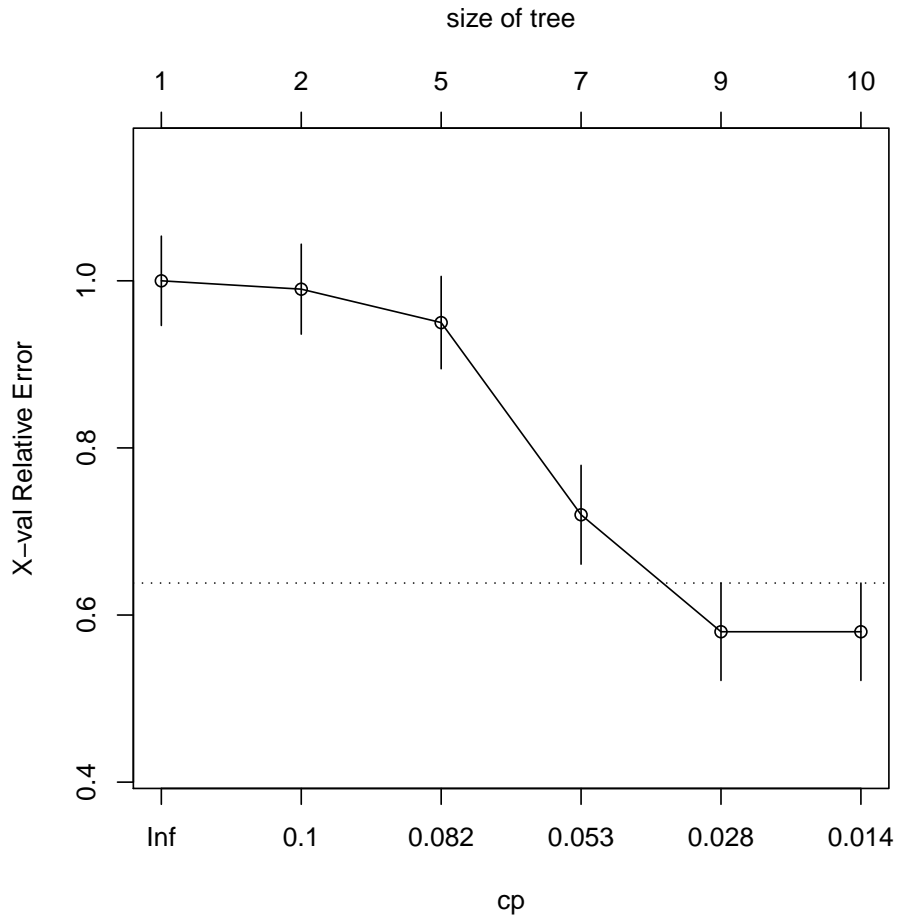

2.6.2 Random forests

A generalization of recursive partitioning is obtained by creating a collection of trees by bootstrap-sampling cases and randomly sampling from features available for splitting at nodes.

```
> set.seed(124)
> library(randomForest)
> rf1 = MLearn(spsex ~ ., crES, randomForestI, 1:140)
> rf1
```

MLInterfaces classification output container

The call was:

```
MLearn(formula = spsex ~ ., data = crES, .method = randomForestI,
        trainInd = 1:140)
```

Predicted outcome distribution for test set:

```
B:F B:M O:F O:M
 18 13 17 12
```

```
> cm = confuMat(rf1)
> cm
```

```
      predicted
given B:F B:M O:F O:M
B:F   15   2   0   0
B:M   1   9   0   0
O:F   1   0  15   2
O:M   1   2   2  10
```

The single split error rate is estimated at 18%.

- *Question 10.* What is the out-of-bag error rate for rf1? Obtain a cross-validated estimate of misclassification error using randomForest with an xvalSpec().

2.6.3 Linear discriminants

```
> ld1 = MLearn(spsex ~ ., crES, ldaI, 1:140)
> ld1
```

MLInterfaces classification output container

The call was:

```
MLearn(formula = spsex ~ ., data = crES, .method = ldaI, trainInd = 1:140)
```

Predicted outcome distribution for test set:

```
B:F B:M O:F O:M
 18  9 18 15
```

```
> confuMat(ld1)
```

```
      predicted
given B:F B:M O:F O:M
B:F   17   0   0   0
B:M   1   9   0   0
O:F   0   0  18   0
O:M   0   0   0  15
```

```
> xvld = MLearn(spsex ~ ., crES, ldaI, xvalSpec("LOG", 5, balKfold.xvspec(5)))
> confuMat(xvld)
```

```

      predicted
given B:F B:M O:F O:M
  B:F  48   2   0   0
  B:M   6  44   0   0
  O:F   0   0  47   3
  O:M   0   0   0  50

```

- *Question 11.* Use the `balkfold` function to generate an index set for partitions that is balanced with respect to class distribution. Check the balance and repeat the cross validation.

2.6.4 Neural net

```
> nn1 = MLearn(spsex ~ ., crES, nnetI, 1:140, size = 3, decay = 0.1)
```

```

# weights:  34
initial  value 236.354190
iter   10 value 191.068212
iter   20 value 125.318872
iter   30 value  50.123864
iter   40 value  37.387002
iter   50 value  36.370167
iter   60 value  35.601717
iter   70 value  35.453834
iter   80 value  33.891860
iter   90 value  32.271953
iter  100 value  32.271118
final   value  32.271118
stopped after 100 iterations

```

```
> nn1
```

```
MLInterfaces classification output container
```

```
The call was:
```

```
MLearn(formula = spsex ~ ., data = crES, .method = nnetI, trainInd = 1:140,
       size = 3, decay = 0.1)
```

```
Predicted outcome distribution for test set:
```

```

B:F B:M O:F O:M
 18  9 18 15

```

```
Summary of scores on test set (use testScores() method for details):
```

```

      B:F      B:M      O:F      O:M
0.2784297 0.1757398 0.3002084 0.2456221

```

```
> RObject(nn1)
```

```
a 5-3-4 network with 34 weights
```

```
inputs: FL RW CL CW BD
```

```
output(s): spsex
```

```
options were - softmax modelling decay=0.1
```

```
> confuMat(nn1)
```

```
      predicted
given B:F B:M O:F O:M
  B:F  17   0   0   0
  B:M   1   9   0   0
  O:F   0   0  18   0
  O:M   0   0   0  15
```

```
> xvnnBAD = MLearn(spsex ~ ., crES, nnetI, xvalSpec("LOG", 5, function(data,
+   clab, iternum) {
+   which(rep(1:5, each = 40) == iternum)
+ }), size = 3, decay = 0.1)
```

```
> xvnnGOOD = MLearn(spsex ~ ., crES, nnetI, xvalSpec("LOG", 5,
+   balkfold.xvspec(5)), size = 3, decay = 0.1)
```

```
> confuMat(xvnnBAD)
```

```
      predicted
given B:F B:M O:F O:M
  B:F  48   2   0   0
  B:M   7  43   0   0
  O:F   0   0  48   2
  O:M   0   0   4  46
```

```
> confuMat(xvnnGOOD)
```

```
      predicted
given B:F B:M O:F O:M
  B:F  48   2   0   0
  B:M   4  46   0   0
  O:F   0   0  49   1
  O:M   0   0   0  50
```

2.6.5 SVM

```
> sv1 = MLearn(spsex ~ ., crES, svmI, 1:140)
> sv1
```

MLInterfaces classification output container

The call was:

```
MLearn(formula = spsex ~ ., data = crES, .method = svmI, trainInd = 1:140)
```

Predicted outcome distribution for test set:

```
B:F B:M O:F O:M
 27  8 13 12
```

```
> RObject(sv1)
```

Call:

```
svm(formula = formula, data = trdata)
```

Parameters:

```
  SVM-Type:  C-classification
  SVM-Kernel: radial
    cost:    1
   gamma:   0.2
```

Number of Support Vectors: 131

```
> confuMat(sv1)
```

```
      predicted
given B:F B:M O:F O:M
  B:F  17  0  0  0
  B:M   3  7  0  0
  O:F   5  0 13  0
  O:M   2  1  0 12
```

```
> xvsv = MLearn(spsex ~ ., crES, svmI, xvalSpec("LOG", 5, balkfold.xvspec(5)))
```

```
> confuMat(xvsv)
```

```
      predicted
given B:F B:M O:F O:M
  B:F  46  1  3  0
  B:M  14 33  0  3
  O:F  14  0 34  2
  O:M   4  2  0 44
```

3 Learning with expression arrays

Here we will concentrate on ALL: acute lymphocytic leukemia, B-cell type.

3.1 Phenotype reduction

We will identify expression patterns that discriminate individuals with BCR/ABL fusion in B-cell leukemia.

```
> library(ALL)
> data(ALL)
> bALL = ALL[, substr(ALL$BT, 1, 1) == "B"]
> fus = bALL[, bALL$mol.biol %in% c("BCR/ABL", "NEG")]
> fus$mol.biol = factor(fus$mol.biol)
> fus
```

```
ExpressionSet (storageMode: lockedEnvironment)
assayData: 12625 features, 79 samples
  element names: exprs
phenoData
  sampleNames: 01005, 01010, ..., 84004 (79 total)
  varLabels and varMetadata description:
    cod: Patient ID
    diagnosis: Date of diagnosis
    ...: ...
    date last seen: date patient was last seen
    (21 total)
featureData
  featureNames: 1000_at, 1001_at, ..., AFFX-YELO24w/RIP1_at (12625 total)
  fvarLabels and fvarMetadata description: none
experimentData: use 'experimentData(object)'
  pubMedIds: 14684422 16243790
Annotation: hgu95av2
```

3.2 Nonspecific filtering

We can nonspecifically filter to 300 genes (to save computing time) with largest measures of robust variation across all samples:

```
> mads = apply(exprs(fus), 1, mad)
> fusk = fus[mads > sort(mads, decr = TRUE)[300], ]
> fcol = ifelse(fusk$mol.biol == "NEG", "green", "red")
```

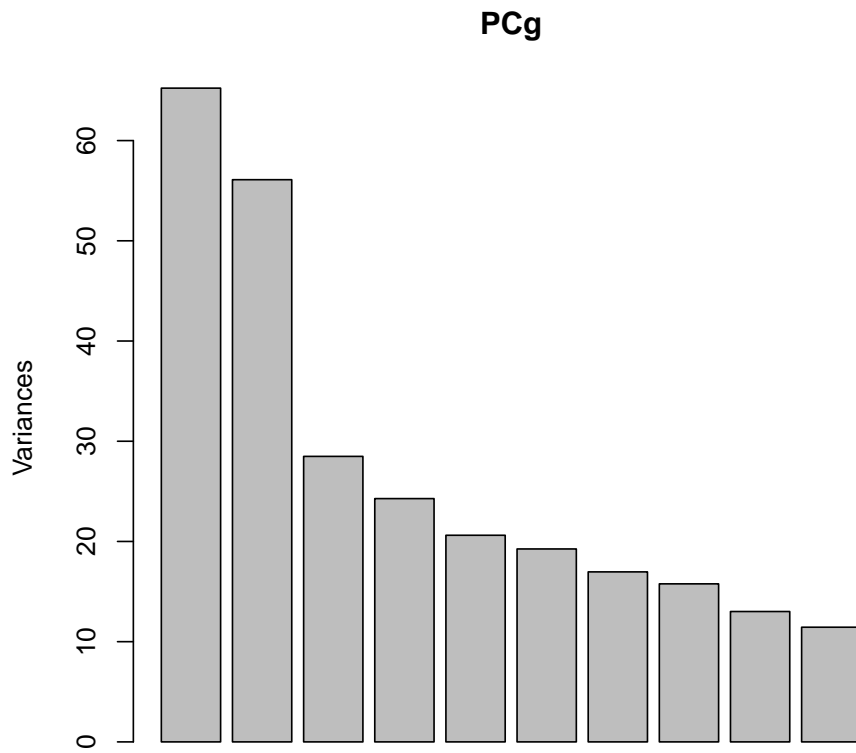
```
> pairs(PCg$x[, 1:5], col = fcol, pch = 19)
```

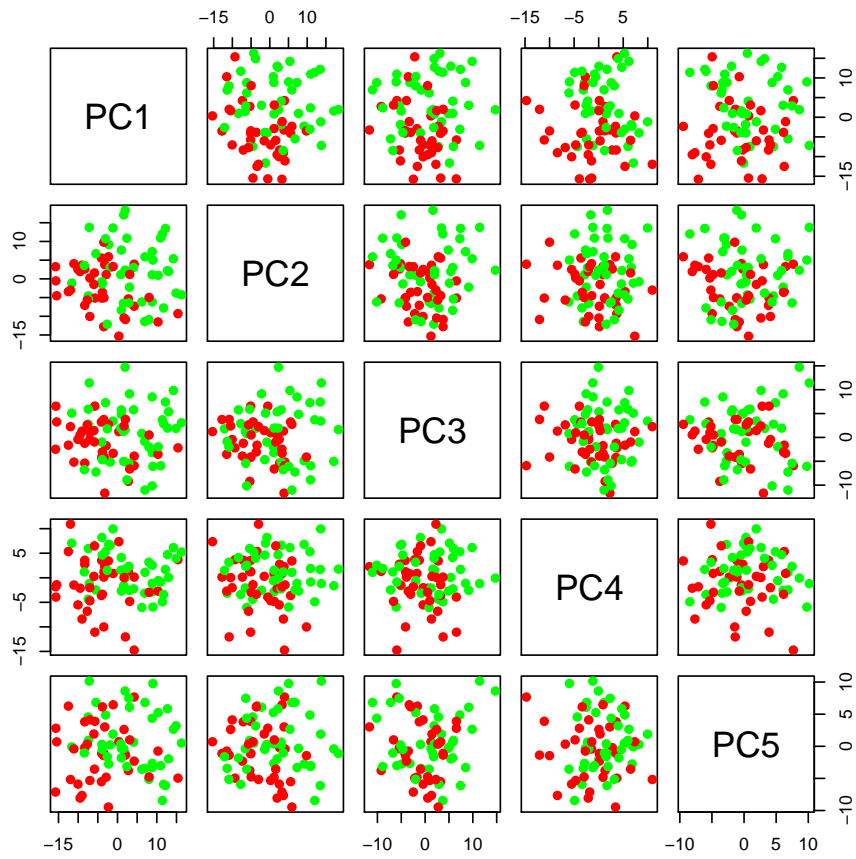

```
> biplot(PCg)
```

- *Question 12.* Modify the biplot so that instead of plotting sample ID, the symbol "O" is plotted for a NEG sample and "+" is plotted for a BCR/ABL sample.
- *Question 13.* Consider the following code

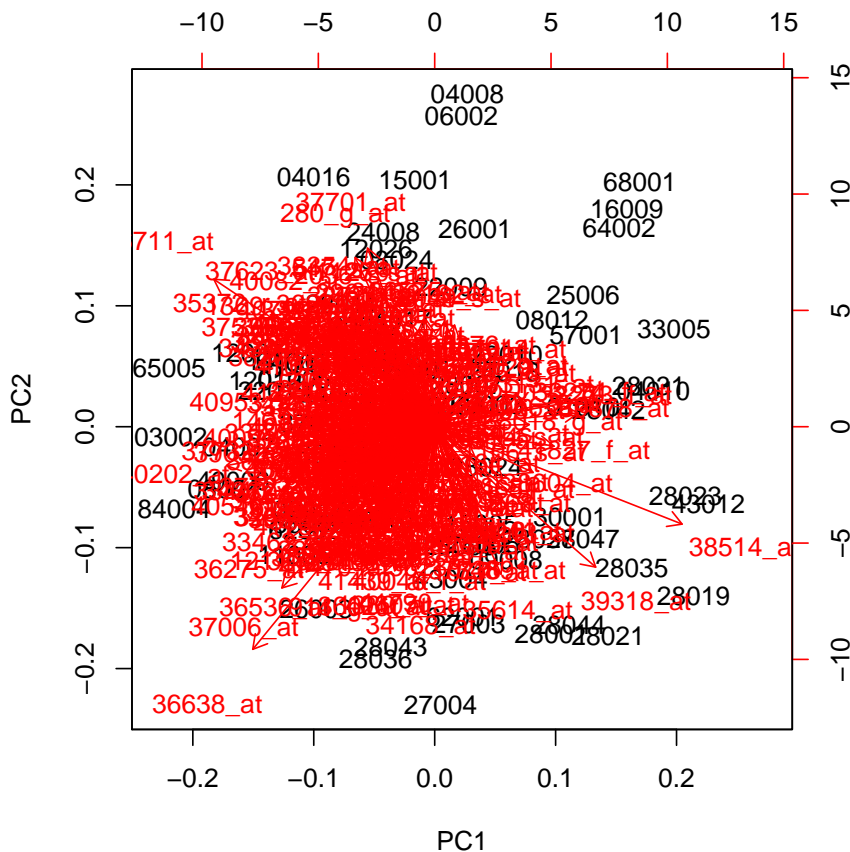
```
chkT = function (x, eset=fusk) {
  t.test(exprs(eset)[x, eset$mol.b == "NEG"], exprs(eset)[x, eset$mol.b ==
    "BCR/ABL"]) }

```

Use it in conjunction with the biplot to interpret expression patterns of genes that appear to be important in defining the PCs.

3.4 Classifier construction

3.4.1 Demonstrations

Diagonal LDA has a good reputation. Let's try it first, followed by neural net and random forests. We will not attend to tuning the latter two, defaults or guesses for key parameters are used.

```
> dld1 = MLearn(mol.biol ~ ., fusk, dldaI, 1:40)
> dld1
```

MLInterfaces classification output container

The call was:

```
MLearn(formula = mol.biol ~ ., data = fusk, .method = dldaI,
        trainInd = 1:40)
```

Predicted outcome distribution for test set:

BCR/ABL	NEG
27	12

```
> confuMat(dld1)
```

	predicted	
given	BCR/ABL	NEG
BCR/ABL	15	1
NEG	12	11

```
> nnALL = MLearn(mol.biol ~ ., fusk, nnetI, 1:40, size = 5, decay = 0.01,
+               MaxNWts = 2000)
```

```
# weights: 1506
initial value 30.706545
iter 10 value 27.726987
iter 20 value 25.392107
iter 30 value 9.871115
iter 40 value 1.945906
iter 50 value 1.158405
iter 60 value 0.875662
iter 70 value 0.827382
iter 80 value 0.745196
iter 90 value 0.657223
iter 100 value 0.651541
final value 0.651541
stopped after 100 iterations
```

```
> confuMat(nnALL)
```

	predicted	
given	BCR/ABL	NEG
BCR/ABL	15	1
NEG	8	15

```
> rfALL = MLearn(mol.biol ~ ., fusk, randomForestI, 1:40)
> rfALL
```

MLInterfaces classification output container

The call was:

```
MLearn(formula = mol.biol ~ ., data = fusk, .method = randomForestI,
        trainInd = 1:40)
```

Predicted outcome distribution for test set:

BCR/ABL	NEG
22	17

```
> confuMat(rfALL)
```

given	predicted	
	BCR/ABL	NEG
BCR/ABL	15	1
NEG	7	16

None of these are extremely impressive, but the problem may just be very hard. An interesting new proposal is RDA, regularized discriminant analysis (package `rda`, Guo, Hastie, Tibshirani 2007 Biostatistics). This algorithm recognizes the fact that covariance matrix estimation in high dimensional data is very inaccurate, so the estimator is shrunk towards the identity. We have a rudimentary interface, in which the key parameters are chosen by native cross-validation (in `rda.cv`) and then applied once to get the final object.

```
> rdaALL = MLearn(mol.biol ~ ., fusk, rdacvI, 1:40)
```

```
> rdaALL
```

MLInterfaces classification output container

The call was:

```
MLearn(formula = mol.biol ~ ., data = fusk, .method = rdacvI,
        trainInd = 1:40)
```

Predicted outcome distribution for test set:

BCR/ABL	NEG
19	20

```
> confuMat(rdaALL)
```

given	predicted	
	BCR/ABL	NEG
BCR/ABL	14	2
NEG	5	18

A by-product of the algorithm is a set of retained genes that were found to play a role in discrimination. This can be established as follows:

```
> library(hgu95av2.db)
> psid = RObject(rdaALL)$keptFeatures
> psid = gsub("^X", "", psid)
> mget(psid, hgu95av2GENENAME)[1:5]

$`1635_at`
[1] "c-abl oncogene 1, receptor tyrosine kinase"

$`1674_at`
[1] "v-yes-1 Yamaguchi sarcoma viral oncogene homolog 1"

$`1857_at`
[1] "SMAD family member 7"

$`1915_s_at`
[1] "FBJ murine osteosarcoma viral oncogene homolog"

$`1916_s_at`
[1] "FBJ murine osteosarcoma viral oncogene homolog"
```

- *Question 14.* How can we assess the relative impacts of regularization (expanding the covariance model beyond that of DLDA, which was shown above to do poorly, but without relying on the full covariance) and implicit feature selection conducted in RDA?

3.4.2 Gene set appraisal

- *Question 15.* We can assess the predictive capacity of a set of genes by restricting the ExpressionSet to that set and using the best classifier appropriate to the problem. We can also assess the incremental effect of combining gene sets, relative to using them separately.

One collection of gene sets that is straightforward to use and interpret is provided by the keggorth package (see also GSEABase). Here's how we can define the ExpressionSets for genes annotated by KEGG to Environmental (Genetic) Information Processing:

```
> library(keggorth)
> data(KOgraph)
> adj(KOgraph, nodes(KOgraph)[1])
```

```

$K0.June07root
[1] "Metabolism"
[2] "Genetic Information Processing"
[3] "Environmental Information Processing"
[4] "Cellular Processes"
[5] "Human Diseases"

> EIP = getK0probes("Environmental Information Processing")
> GIP = getK0probes("Genetic Information Processing")
> length(intersect(EIP, GIP))

[1] 50

> EIPi = setdiff(EIP, GIP)
> GIP = setdiff(GIP, EIP)
> EIP = EIPi
> Efusk = fusk[featureNames(fusk) %in% EIP, ]
> Gfusk = fusk[featureNames(fusk) %in% GIP, ]

```

Obtain and assess the predictive capacity of the genes annotated to "Cell Growth and Death".

- *Question 16.* How many of the genes identified by RDA as important for discriminating fusion are annotated to Genetic Information Processing in the KEGG orthology?

4 Embedding features selection in cross-validation

We provide helper functions to conduct several kinds of feature selection in cross-validation, see `help(fs.absT)`. Here we pick the top 30 features (ranked by absolute t statistic) for each cross-validation partition.

```

> dldFS = MLearn(mol.biol ~ ., fusk, dldaI, xvalSpec("LOG", 5,
+      balKfold.xvspec(5), fs.absT(30)))
> dldFS

```

MLInterfaces classification output container

The call was:

```

MLearn(formula = mol.biol ~ ., data = fusk, .method = dldaI,
      trainInd = xvalSpec("LOG", 5, balKfold.xvspec(5), fs.absT(30)))

```

Predicted outcome distribution for test set:

```

BCR/ABL      NEG

```

42 37

history of feature selection in cross-validation available; use `fsHistory()`

```
> confuMat(dld1)
```

	predicted	
given	BCR/ABL	NEG
BCR/ABL	15	1
NEG	12	11

```
> confuMat(dldFS)
```

	predicted	
given	BCR/ABL	NEG
BCR/ABL	34	3
NEG	8	34

5 Learning with array CGH

This section contains two parts, one of which is left as a pair of open questions. In the first part, we use `rpart` as a *device* to perform segmentation of aCGH log intensity ratios. In the second part, we consider how to extract features from the CGH profile to learn about gene cluster activation and phenotype.