

VLS user guide

Cyril Deguet

Alexis de Lattre

Copyright © 2002, 2003 the VideoLAN project

This document is the complete user guide of VLS .

Permission is granted to copy, distribute and/or modify this document under the terms of the GNU Free Documentation License, Version 1.2 or any later version published by the Free Software Foundation ; with no Invariant Sections, with no Front-Cover Texts, and with no Back-Cover Texts. The text of the license can be found in the appendix *GNU Free Documentation License*.

Table of Contents

Chapter 1. Introduction	1
<u>1.1. What is the VideoLAN project ?</u>	1
1.1.1. Overview.....	1
1.1.2. VideoLAN software.....	2
1.2. What is a codec ?.....	3
1.3. How can I use VideoLAN ?.....	3
1.3.1. Documentation.....	3
1.3.2. User support.....	4
1.4. Command line usage.....	4
1.4.1. Open a terminal.....	4
Chapter 2. Installing VLS	8
<u>2.1. Installing VLS</u>	8
2.1.1. Windows.....	8
2.1.2. GNU/Linux & Mac OS X.....	8
2.2. Uninstalling VLS.....	9
2.2.1. Windows.....	9
2.2.2. If you compiled VLS from sources.....	9
Chapter 3. Overview and basic concepts	10
<u>3.1. VLS structure</u>	10
3.1.1. Input.....	10
3.1.2. Converter.....	10
3.1.3. Channel.....	11
3.1.4. Manager.....	11
3.2. Administration interface.....	11
Chapter 4. Configuration	12
4.1. General structure.....	12
4.2. Writing a vls.cfg.....	12
4.2.1. Section "Vls".....	12
4.2.2. Section "Groups".....	13
4.2.3. Section "Users".....	13
4.2.4. Section "Telnet".....	14
4.2.5. Section "NativeAdmin".....	14
4.2.6. Section "Inputs".....	14
4.2.7. Inputs configuration.....	15
4.2.8. Section "Channels".....	16
4.2.9. Channels configuration.....	16
4.2.10. Programs Configuration.....	18
Chapter 5. Running VLS	21
5.1. Launching VLS.....	21
5.2. Using the telnet interface.....	21
5.3. Interface commands.....	22
5.3.1. help.....	22
5.3.2. browse.....	22
5.3.3. start.....	22

Table of Contents

Chapter 5. Running VLS

<u>5.3.4. stop</u>	22
<u>5.3.5. forward</u>	22
<u>5.3.6. rewind</u>	23
<u>5.3.7. suspend</u>	23
<u>5.3.8. resume</u>	23
<u>5.3.9. logout</u>	23
<u>5.3.10. shutdown</u>	23

Appendix A. GNU Free Documentation License.....24

<u>A.1. PREAMBLE</u>	24
<u>A.2. APPLICABILITY AND DEFINITIONS</u>	24
<u>A.3. VERBATIM COPYING</u>	25
<u>A.4. COPYING IN QUANTITY</u>	26
<u>A.5. MODIFICATIONS</u>	26
<u>A.6. COMBINING DOCUMENTS</u>	27
<u>A.7. COLLECTIONS OF DOCUMENTS</u>	28
<u>A.8. AGGREGATION WITH INDEPENDENT WORKS</u>	28
<u>A.9. TRANSLATION</u>	28
<u>A.10. TERMINATION</u>	29
<u>A.11. FUTURE REVISIONS OF THIS LICENSE</u>	29
<u>A.12. ADDENDUM: How to use this License for your documents</u>	29

Chapter 1. Introduction

1.1. What is the VideoLAN project ?

1.1.1. Overview

VideoLAN is a complete software solution for video streaming, developed by students of the Ecole Centrale Paris and developers from all over the world, under the GNU General Public License (GPL). VideoLAN is designed to stream MPEG videos on high bandwidth networks.

The VideoLAN solution includes :

- VLS (VideoLAN Server), which can stream MPEG-1, MPEG-2 and MPEG-4 files, DVDs, digital satellite channels, digital terrestrial television channels and live videos on the network in unicast or multicast,
- VLC (initially VideoLAN Client), which can be used as a server to stream MPEG-1, MPEG-2 and MPEG-4 files, DVDs and live videos on the network in unicast or multicast ; or used as a client to receive, decode and display MPEG streams under multiple operating systems.

Here is an illustration of the complete VideoLAN solution :

Figure 1-1. Global VideoLAN solution La solution VideoLAN globale

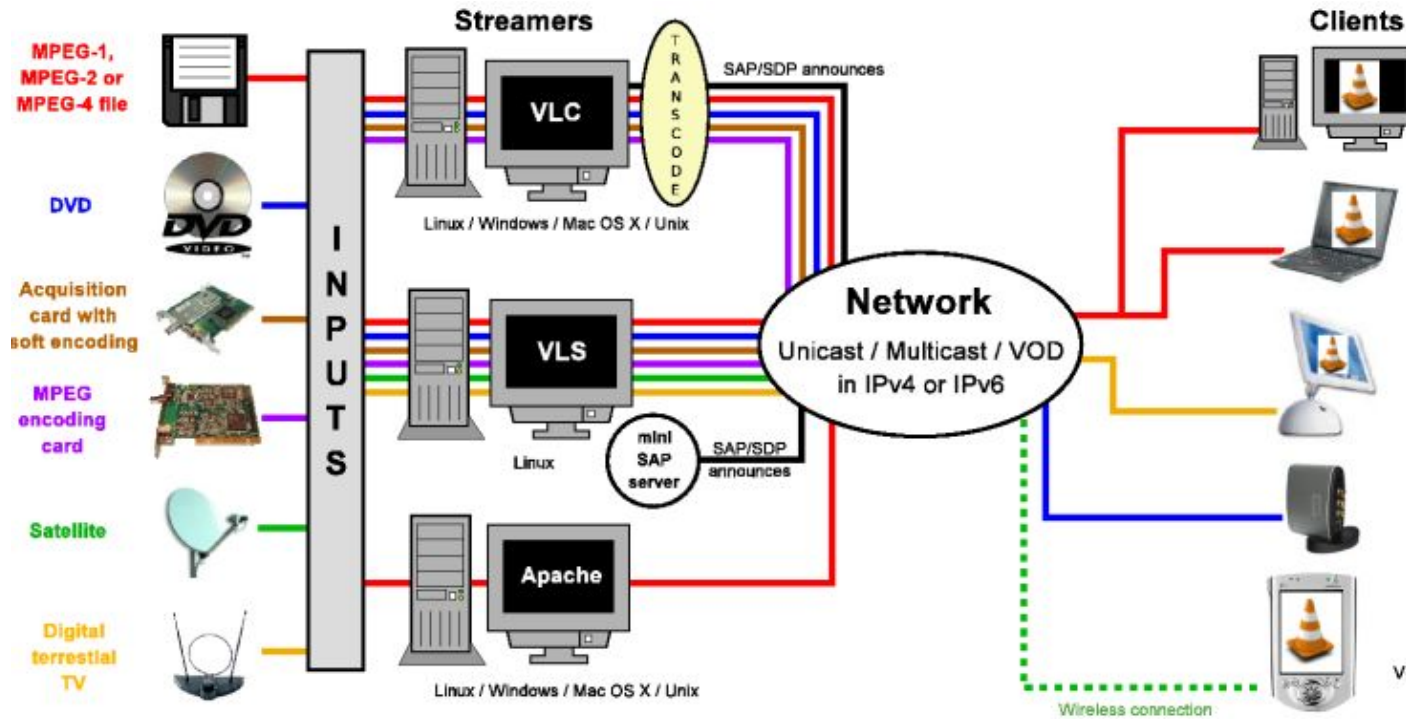

More details about the project can be found on the [VideoLAN Web site](#).

1.1.2. VideoLAN software

1.1.2.1. VLC

VLC works on many platforms : Linux, Windows, Mac OS X, BeOS, *BSD, Solaris, Familiar Linux, Yopy/Linupy and QNX. It can read :

- MPEG-1, MPEG-2 and MPEG-4 / DivX files from a hard disk, a CD-ROM drive, ...
- DVDs and VCDs,
- from a satellite card (DVB-S),
- MPEG-1, MPEG-2 and MPEG-4 streams from the network sent by VLS or VLC's stream output.

VLC can also be used as a server to stream :

- MPEG-1, MPEG-2 and MPEG-4 / DivX files,
- DVDs,
- from an MPEG encoding card,

to :

- one machine (i.e. to one IP address) : this is called *unicast*,
- a dynamic group of machines that the clients can join or leave (i.e. to a multicast IP address) : this is called *multicast*,

in IPv4 or IPv6 .

To get the complete list of VLC's possibilities on each platform supported, see the [VLC features page](#).



VLC doesn't work on Mac OS 9, and will probably never do.

1.1.2.2. VLS

VLS can stream :

- an MPEG-1, MPEG-2 or MPEG-4 files stored on a hard drive or on a CD,
- a DVD located in a local DVD drive or copied on a hard disk,
- a satellite card (DVB-S) or a digital terrestrial television card (DVB-T) ,
- an MPEG encoding card ;

to:

- one machine (i.e. to one IP address) : this is called *unicast*,
- a dynamic group of machines that the clients can join or leave (i.e. to a multicast IP address) : this is called *multicast*,

in IPv4 or IPv6 .

A Pentium 100 MHz with 32 MB of memory should be enough to send one stream on the network. When streaming a lot of videos stored on a hard drive, the actual limitation is not the processor but the hard drive and the network connection.

VLS works under Linux and Windows. To get the complete list of VLS's possibilities on each platform supported, see the [streaming features page](#).

1.1.2.3. Mini-SAP-server

You can add a channel information service based on the SAP/SDP standard to the VideoLAN solution. The mini-SAP-server sends announces about the multicast programs on the network in IPv4 or IPv6, and VLCs receive these announces and automatically add the programs announced to their playlist.

The mini-SAP-server works under Linux and Mac OS X.

1.2. What is a codec ?

To fully understand the VideoLAN solution, you must understand the difference between a *codec* and a *container format*

- A *codec* is a compression algorithm, used to reduce the size of a stream. There are audio codecs and video codecs. MPEG-1, MPEG-2, MPEG-4, Vorbis, DivX, ... are codecs
- A *container format* contains one or several streams already encoded by codecs. Very often, there is an audio stream and a video one. AVI, Ogg, MOV, ASF, ... are container formats. The streams contained can be encoded using different codecs. In a perfect world, you could put any codec in any container format. Unfortunately, there are some incompatibilities. You can find a matrix of possible codecs and container formats on the [features page](#)

To decode a stream, VLC first *demuxes* it. This means that it reads the container format and separates audio, video, and subtitles, if any. Then, each of these are passed *decoders* that do the mathematical processing to decompress the streams .

There is a particular thing about MPEG:

- MPEG is a *codec*. There are several versions of it, called MPEG-1, MPEG-2, MPEG-4, ...
- MPEG is also a container format, sometimes referred to as *MPEG System*. There are several types of MPEG: ES, PS, and TS

When you play an MPEG video from a DVD, for instance, the MPEG stream is actually composed of several streams (called Elementary Streams, ES): there is one stream for video, one for audio, another for subtitles, and so on. These different streams are mixed together into a single Program Stream (PS). So, the .VOB files you can find in a DVD are actually MPEG-PS files. But this PS format is not adapted for streaming video through a network or by satellite, for instance. So, another format called Transport Stream (TS) was designed for streaming MPEG videos through such channels.

1.3. How can I use VideoLAN ?

1.3.1. Documentation

The user documentation of VideoLAN is made up of 4 documents :

- the *VideoLAN Quickstart*. This document will give you a quick overview of of VLC, VLC's stream output, the Video On Demand solution and the channel information service system.

VLS user guide

- the *VideoLAN HOWTO*. This document is the complete guide of the VideoLAN streaming solution.
- the *VLC user guide*. This document is the complete guide for VLC.
- the *VLS user guide*. This document is the complete guide for VLS.
- the *VideoLAN FAQ*. This document contains Frequently Asked Questions about VideoLAN.

The latest version of these documents can be found on the [documentation page](#) .

You can also have a look at the [VideoLAN Wiki](#). This is a website that everyone can change. We use it to document everything that is not in the "official" documentation: the tips and tricks for each O.S., the graphical interfaces, etc...

1.3.2. User support

If you have problems using VideoLAN, and if you don't find the answer to your problems in the documentation, please look at the [online archive of the mailing-lists](#). There are two English-speaking mailing-lists for the users :

- vlc@videolan.org for the questions on VLC ,
- streaming@videolan.org for the questions on VLS, mini-SAP-server and the network .

If you want to subscribe or unsubscribe to the mailing-lists, please go to the [mailing-list page](#).

You can also talk with VideoLAN users and developers on IRC : server [irc.freenode.net](irc://irc.freenode.net), channel [#videolan](#) .

If you find a bug, please follow the instructions on the [bug reporting page](#) .

1.4. Command line usage

- VLC has many different graphical interfaces, that are organized quite differently in order to be in harmony with the guidelines of each operating system supported. Documenting the use of each graphical interface is too long, and some features are only available via the command line interface. Therefore we decided to document only the command line interface, but in many cases it should be easy to guess how to use the graphical interface for the same use !
- VLS has a command line and a telnet interface, but no graphical interface !

All the commands that show up in this document should be typed inside a terminal. .

1.4.1. Open a terminal

1.4.1.1. Windows

Click on *Start, Run* and type :

- **cmd Enter** (Windows 2000 / XP),
- **command Enter** (Windows 95 / 98 / ME).

The terminal appears Le terminal apparait

Figure 1–2. Windows terminal

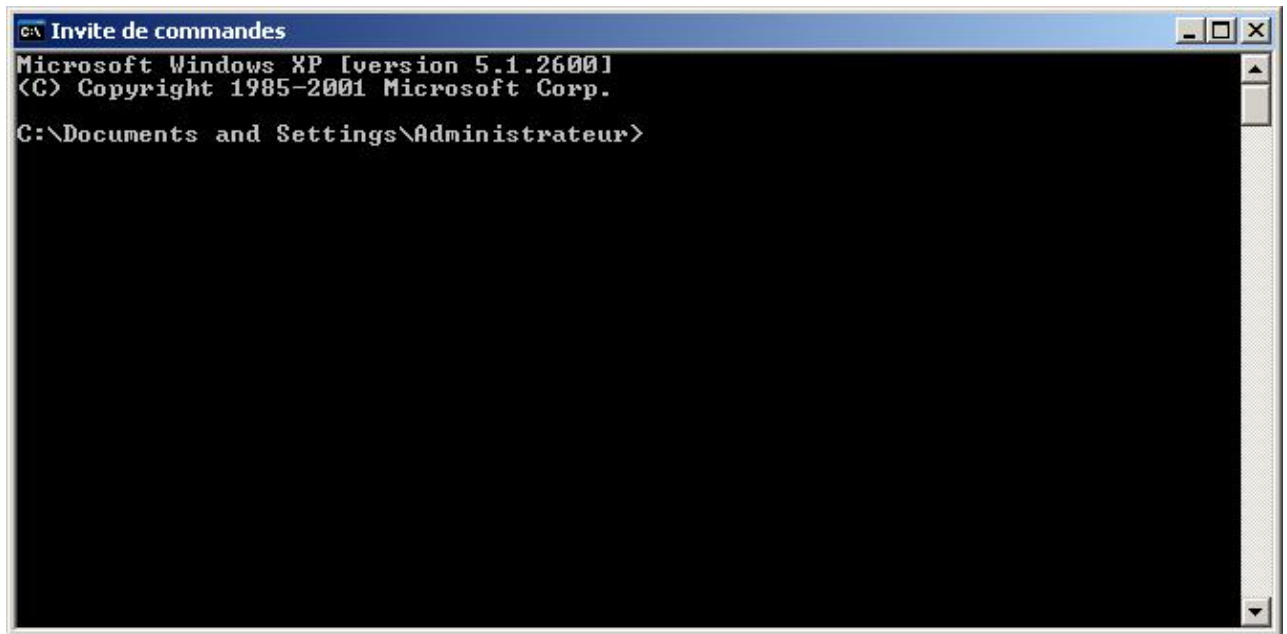

 Under Windows, you need to be in the directory where the program is installed to run it.

1.4.1.2. Linux / Unix

Open a terminal :

Figure 1–3. Linux X terminal



In the documentation, we adopt the following conventions for the Unix commands :

- commands that should be typed as *root* have a # prompt :

```
# command_to_be_typed_as_root
```

- commands that should be typed as a regular user have a % prompt :

```
% command_to_be_typed_as_regular_user
```

1.4.1.3. Mac OS X

Go to *Applications*, open the folder *Utilities* and double-click on *Terminal* :

Figure 1–4. Mac OS X terminal

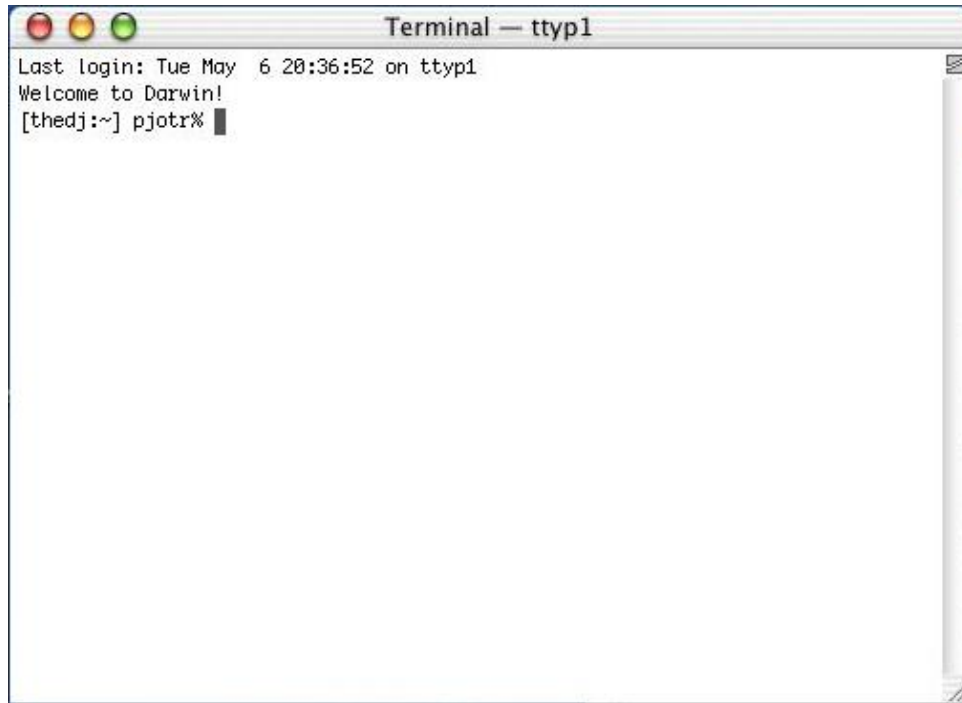

 Under Mac OS X, you need to be in the directory where the program is installed to run it, and start the command with `./`.

1.4.1.4. BeOS

In the deskbar, go to *Application* and then *Terminal* :

Figure 1–5. BeOS terminal

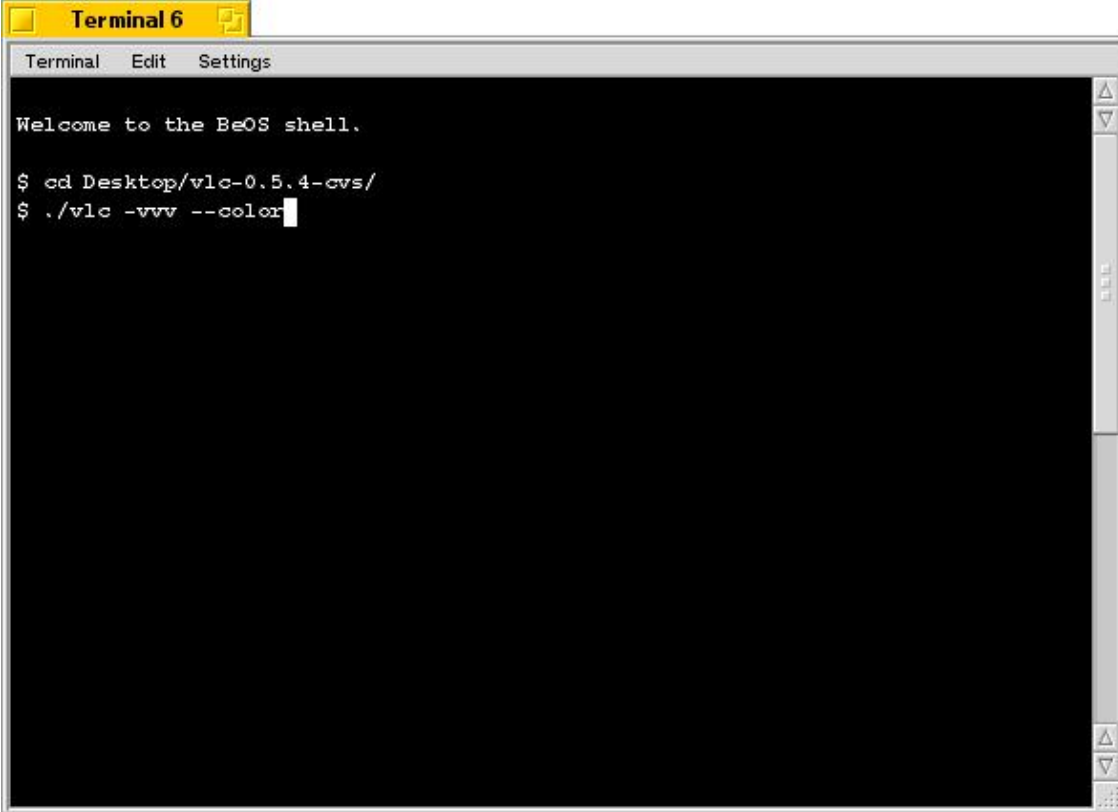
A screenshot of a BeOS Terminal window titled "Terminal 6". The window has a menu bar with "Terminal", "Edit", and "Settings". The terminal text shows a shell prompt, a welcome message, and two commands: "cd Desktop/vlc-0.5.4-cvs/" and "./vlc -vvv --color".

```
Terminal 6
Terminal Edit Settings
Welcome to the BeOS shell.
$ cd Desktop/vlc-0.5.4-cvs/
$ ./vlc -vvv --color
```

 Under BeOS, you need to be in the directory where the program is installed to run it, and start the command with `./`.

Chapter 2. Installing VLS

2.1. Installing VLS

2.1.1. Windows

Download the ZIP file from the [VLS Windows download page](#), unzip-it and run `setup.exe`.

2.1.2. GNU/Linux & Mac OS X

2.1.2.1. Install the libraries

Many libraries are needed for particular uses

- *libdvbpsi* (always needed)
- *libdvdcss* if you want to be able to access encrypted DVDs ,
- *libdvddread* if you want to be able to stream DVDs ,
- *libdvb* if you want to be able to stream from a DVB card (a satellite card or a digital terrestrial TV card) .

Download the libraries from the [VLS sources download page](#) .

For each library, uncompress, configure (unless for *libdvb* which doesn't have a *./configure*), compile and install :

```
% tar xvzf library.tar.gz
% cd library
% ./configure
% make
# make install
```

Check that the configuration file `/etc/ld.so.conf` contains the following line :

```
/usr/local/lib
```

If the line is not present, add-it and then run :

```
# ldconfig
```

2.1.2.2. Install VLS

Download the sources of the latest release : get the file `vls-version.tar.gz` from the [VLS sources download page](#). Uncompress-it and generate *./configure* :

```
% tar xvzf vls-version.tar.gz
% cd vls-version
```

To get the list of configuration options, do

```
% ./configure --help
```

Then configure vls :

- if you want a basic VLS without DVD support, do :

```
% ./configure --disable-dvd
```

- if you want a VLS with DVD support, do :

```
% ./configure
```

- if you want a VLS with DVB support, do :

```
% ./configure --enable-dvb --with-dvb=PATH_TO_DVB_DRIVERS --with-libdvd=PATH_TO_LIBDVB
```

Then, compile and install :

```
% make  
# make install
```

You can also do a **make uninstall**, **make clean** or **make distclean** as needed .

2.2. Uninstalling VLS

2.2.1. Windows

Go to the *Control Panel*, click on *Add and remove programs*, select *VLS* and click on *Modify/Remove* and follow the steps to uninstall the program .

2.2.2. If you compiled VLS from sources

Go to the directory containing VLS sources and run :

```
# make uninstall
```

Then you can remove the VLS sources .

Chapter 3. Overview and basic concepts

3.1. VLS structure

From a user's point of view, VLS can be divided into four kinds of components :

- a *manager* ,
- *inputs* ,
- *converters* ,
- et des *sorties* .

Figure 3–1. VLS structure

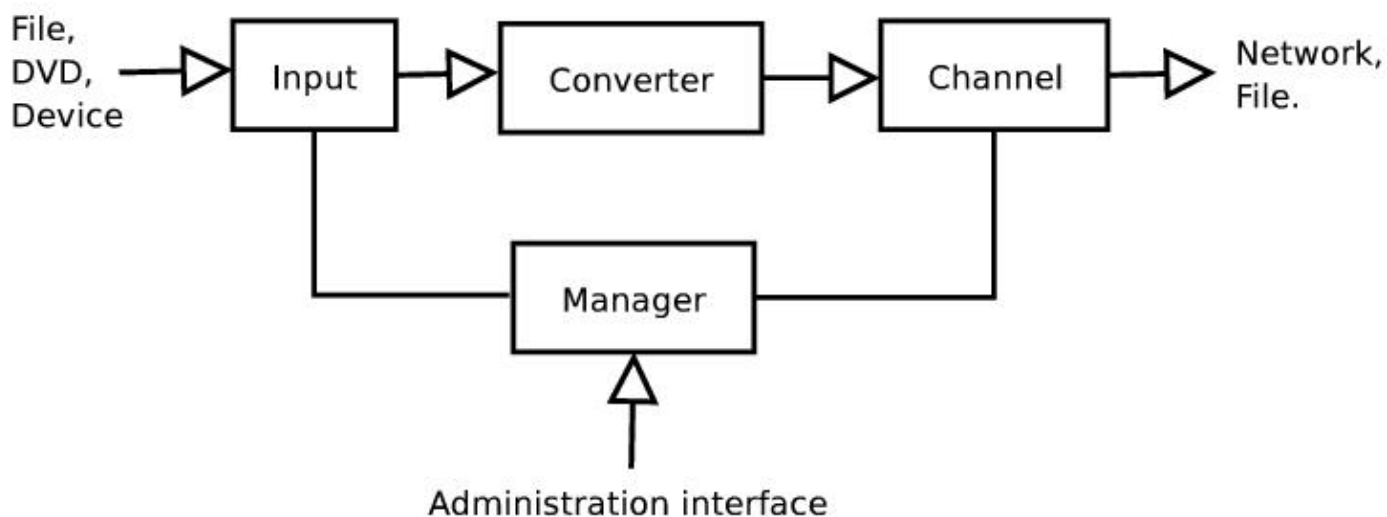

3.1.1. Input

The role of an *input* is to read MPEG streams from a given source (file, DVD, DVB card, device, ...), and feed the right *converters* with these streams. An input may be able to read several streams, which are called *programs*. There are several kinds of inputs :

- the *local* input, which can read videos from files or DVDs ,
- the *video* input, which can read videos from MPEG encoding cards devices ,
- the *dvb* input, which can read videos from DVB cards, l'entrée *dvb*, qui peut lire depuis des cartes DVB,
- the *v4l* input, which can read from acquisition cards supported by the Video4Linux drivers .

You can use several inputs and play several programs at the same time .

3.1.2. Converter

The role of a *converter* is to receive a stream from an input, and convert it into the MPEG-TS format. VLS is able to convert PS streams (from DVDs, for instance) into TS streams (ps2ts converter). Of course, it can also

read TS streams, and fix them by handling stream discontinuities (ts2ts converter) .

3.1.3. Channel

A *channel* receives a stream from a converter, and send it to a given destination (network, file, ...). If you want, you can call a "channel" an "output": it is the same thing !). Currently, two kinds of channels are supported: *network* and *file*. Note that, at the moment, VLS can support only one output per stream, so you cannot play a stream on the network and write it into a file at the same time. The network output is highly configurable: you can choose which network interface you want to use, and specify source and destination IP addresses .

3.1.4. Manager

The *manager* controls the way streams are sent. Through an *administration interface*, you can tell the manager to start, stop, suspend, resume, forward or rewind the different programs. You can also get a list of all programs available in the Program Table. The manager gets this table from the VLS configuration file (`vls.cfg`), so it cannot be changed once VLS has been started. At the moment, you cannot ask the manager whether a given stream is being broadcasted, but you will get an error message if you try to stop a stream that was not broadcasted .

3.2. Administration interface

There are currently two ways to launch the streaming :

- you can use the *command line* to give arguments at startup;
- or you can use the *telnet interface* to start/stop/pause the streaming whenever you want .

When using the telnet interface, you must authenticate before typing any command, because any user may not be allowed to execute any command (this can be configured in the `vls.cfg` configuration file) .

Chapter 4. Configuration

VLS reads its configuration from the `vls.cfg` configuration file, which is supposed to be located in the current directory or in `SYSCONF_DIR/videolan/vls` (where `SYSCONF_DIR` is `/usr/local/etc` if you built and installed VLS by hand, or is `/etc` if you installed the debian binary package).

To write a `vls.cfg` file, use the one supplied with VLS as a start-point.

4.1. General structure

VLS configuration file `vls.cfg` is divided into sections, and each section may contain several variables :

```
BEGIN "FirstSection"
  Variable1 = "value1"
  Variable2 = "value2"
  [...]
END

BEGIN "SecondSection"
  Variable1 = "value1"
  Variable3 = "value3"
  [...]
END

[...]
```

All section names, variable names and values are not case-sensitive. There can be empty sections and subsections. Comments must follow a `#` character. Some variables have a default value; it means that you can omit to declare these variables, and then they will be given their default value.

4.2. Writing a `vls.cfg`

Here is an explanation of all the sections you can find in a `vls.cfg` :

4.2.1. Section "Vls"

This section contains application wide settings.

```
LogFile = "name"
```

Name of VLS log file. If left empty "", then no logging to files is done. Default is "vls.log".

```
SystemLog = "[disable|enable]"
```

Logging to the SystemLog. Today, only the SystemLog using syslogd is implemented: compile with `./configure --enable-syslog`.



If VLS is started as `vlsd`, then the following configuration is mandatory :

```
BEGIN "Vls"
  LogFile   = ""
  SystemLog = "enabled"
  ScreenLog = "disabled"
END
```

```
ScreenLog = "[disable|enable]"
```

Logging to the console .

Example :

```
BEGIN "Vls"
  LogFile   = "vls.log"
  SystemLog = "disable"
  ScreenLog = "enable"
END
```

4.2.2. Section "Groups"

In this section, you can define some groups of users, and which commands these users are allowed to execute. For each group you want to define, you must add a line in the following format :

```
groupname = "command1|command2|..."
```

This adds a group "groupname", the users of which are allowed to execute command1, command2, and so on. At the moment, the available commands are: help, browse, start, suspend, resume, forward, rewind, stop, shutdown, logout .

Example :

```
BEGIN "Groups"
  monitor = "help|browse|logout"
  master  = "help|browse|start|resume|suspend|forward|rewind|stop|shutdown|logout"
END
```

4.2.3. Section "Users"

This section contains a list of users allowed to control VLS through an administration interface. For each user, add a line in the following format :

```
username = "password:groupname"
```

This adds a user "username", who belongs to the group "groupname" (defined in the "Groups" section) and can log in with the password "password" .

- Under Unix/Linux, the password must be encrypted, with a tool such as **mkpasswd**, or with the UNIX function "crypt" .
- Under Windows, the password must be in clear text .

Example for Unix/Linux :

```
BEGIN "Users"
  monitor = "3BcKWoiQn0vi6:monitor"      # password is 'monitor'
  admin   = "42BKiCguFAL/c:master"      # password is 'Vir4Gv5S'
END
```

4.2.4. Section "Telnet"

In this section, you can configure the telnet administration interface .

```
LocalPort = "port"
```

Defines which port will be used for the telnet server. Default port is "9999" .

```
Domain = "domain"
```

Either "inet4" or "inet6" (default is "inet4"). If you want to use IPv4 addresses, put "inet4", and if you want to use IPv6, put "inet6" .

```
LocalAddress = "IP address"
```

Defines on which IP address the telnet server will listen for requests. Default address is "0.0.0.0" (or "0::0" with IPv6) .

Example :

```
BEGIN "Telnet"
  LocalPort = "9999"
END
```

4.2.5. Section "NativeAdmin"

Same syntax as "Telnet". Not used yet .

4.2.6. Section "Inputs"

In this section, you can define which inputs you want to use. For each input you need, add a line in the following format :

```
InputName = "Type"
```

This adds a input named "InputName", the type of which is "Type". As explained before, there are several types of input :

- "local" to play a stream from a file or a DVD ,
- "video" to play a stream from an MPEG encoding card ,
- "dVB" to play a stream from a DVB card ,
- "v4l" to play a stream from a Video4Linux device .

Each input must be configured in its own section (see next paragraph) .

Example :

```
BEGIN "Inputs"
  local1 = "local"
  pvr     = "video"
  dvb1    = "dvb"
  tuner   = "v4l"
END
```

4.2.7. Inputs configuration

For each input declared in the "Inputs" section, excepted "local" inputs, you must add a section with the same name as the corresponding input. For instance, if you declared an input "pvr", there should be one section named "pvr" too. The syntax of such sections depends on the type of the corresponding input .

To configure a local input, you don't have to do anything. Except when another trickplay strategy must be used :

```
BEGIN "Local1"
  ProgramCount = "1"
  TrickPlay    = "normal"
END
```

"Local1" is the name of the local input you want to configure. "ProgramCount" is the number of programs assigned to this input. "TrickPlay" is the trickplay strategy that is used by this input (default is "normal") .

To configure a video input, add a section in the following format :

```
BEGIN "VideoInputName"
  Device = "device"
  Type   = "type"
END
```

"VideoInputName" is the name of the video input you want to configure. "Device" is the path of the MPEG encoding card you want to read from (default is "/dev/video0"). "Type" is either "Mpeg2-PS" or "Mpeg2-TS", depending on your device configuration (default is "Mpeg2-PS") .

Example for a Hauppauge WinTV-PVR-250 card :

```
BEGIN "pvr"
  Device = "/dev/video0"
  Type   = "Mpeg2-PS"
END
```

To configure a dvb input, add a section in the following format :

```
BEGIN "DvbInputName"
  DeviceNumber = "devicenumber"
  SendMethod   = "0"
END
```

"DvbInputName" is the name of the dvb input you want to configure. Set "SendMethod" to "0" if you to stream the complete DVB stream and set it to "1" if you only want to stream the MPEG audio and video

streams (default is "0"). "DeviceNumber" is the number of the DVB device you want to read from (read from /dev/ost/dvr<devicenumber>, default is ""). The dvb configuration file is defined by the driver. You can find it in \$HOME/.dvbrc for /dev/dvb/adapater0 or in \$HOME/.dvbrc.X for /dev/dvb/adapaterX .

Example :

```
BEGIN "dvb1"
  DeviceNumber = "0"
  TrickPlay = "normal"
END
```

4.2.8. Section "Channels"

In this section, you can define the channels (outputs) you want to use. For each channel, write a line in the following format :

```
ChannelName = "Type"
```

This adds a channel named "ChannelName", the type of which is "Type". "Type" must be either "network" or "file". Like inputs, channels must be configured in their own section .

Example :

```
BEGIN "Channels"
  localhost = "network"
  client1 = "network"
  client2 = "network"
  multicast1 = "network"
  multicast2 = "network"
  localfile = "file"
END
```

4.2.9. Channels configuration

For each channel declared in the "Channels" section, you must add a section with the same name as the corresponding channel. The syntax of such a section depends on the type of the corresponding channel .

To configure a network channel, add a section in the following format :

```
BEGIN "NetChannelName"
  Domain = "Domain"
  Type = "Type"
  SrcHost = "SourceHost"
  SrcPort = "SourcePort"
  DstHost = "DestHost"
  DstPort = "DestPort"
  TTL = "ttl"
  Interface = "Interface"
END
```

- "NetChannelName" is the name of the network channel you want to configure .
- "Domain" is either "inet4" if you use IPv4 addresses, or "inet6" if you use IPv6 (default is "inet4") .

VLS user guide

- "Type" is either "unicast", "broadcast" or "multicast" (default is "unicast"), depending on what you want to do (and on your "DstHost" address) .
- "SourceHost" is the IP address (or DNS name) from which VLS will send the stream .
- "SourcePort" is the UDP port from which the stream will be sent .
- "DestHost" is the IP address (or DNS name) to which the stream will be sent .
- "DestPort" is the UDP port to which the stream will be sent (default is "1234") .
- "TTL" is an option useful only if "Type" is "multicast" (default value is "0"). You can use it to increase the TTL of your multicast packets if they have to cross several routers .
- "Interface" is an option only supported under GNU/Linux, to force the stream to be sent through a given network interface, "eth1" for instance" (to use this option, you must have super-user permissions) .



"SrcHost" and "SrcPort" are optional (if you don't set them, VLS will not 'bind' the socket) .

To configure a file channel, add a section in the following format :

```
BEGIN "FileChannelName"  
  FileName = "file"  
  Append   = "append"  
END
```

"FileChannelName" is the name of the file channel you want to configure. "file" is the name of the file where the stream will be stored (default is "fileout.ts"). "append" is either "yes" or "no", and indicates whether VLS will append the stream at the end of the file, or rewrite it .

Example :

```
BEGIN "localhost"           # The client is on the same host as the server  
  DstHost = "localhost"  
  DstPort = "1234"  
END  
  
BEGIN "client1"            # unicast towards client1  
  DstHost = "192.168.1.2"  
  DstPort = "1234"  
END  
  
BEGIN "client2"           # unicast towards client2 in IPv6  
  Domain  = "inet6"  
  DstHost = "3ffe:ffff::2:12:42"  
  DstPort = "1234"  
END  
  
BEGIN "multicast1"        # multicast streaming  
  Type    = "multicast"  
  DstHost = "239.2.12.42"  
  DstPort = "1234"  
  TTL     = "2"  
END  
  
BEGIN "multicast2"        # multicast streaming in IPv6  
  Domain  = "inet6"  
  Type    = "multicast"  
  DstHost = "ff08::1"  
  DstPort = "1234"  
  TTL     = "12"
```

```
END
BEGIN "localfile"          # file output
  FileName = "stream.ts"
  Append   = "no"
END
```

 If you use Windows, you should specify the "SrcHost" and "SrcPort" fields. For example :

```
BEGIN "client1"          # The client is on the same host as the server
  SrcHost = "192.168.1.1" # IP of VLS
  SrcPort = "1242"        # Source port : the value is not important
  DstHost = "192.168.1.2" # IP of the client
  DstPort = "1234"
END
```

4.2.10. Programs Configuration

As explained before, you must define the programs. Each one is a MPEG stream (a file, for example). To do this, you must add an "Input" section in your `vls.cfg` file. Each "Input" section must have the following syntax :

```
BEGIN "Input"
  FilesPath   = "path"
  ProgramCount = "count"
END
```

"path" is the path where your MPEG files are located (by default it is the current directory). "count" is the number of programs defined ("0" by default) .

For each program you want to define, you must add a section with the following format :

```
BEGIN "number"
  Name      = "name"
  Type      = "type"
  FileName  = "file"
  Device    = "device"
END
```

- "number" is the program number: the first program has number 1, the second number 2, and so on .
- "name" is the program name, by which you will tell VLS to start this program (see next chapter "Running VLS") .
- "type" can be "Mpeg1-PS", "Mpeg2-PS", "Mpeg2-TS", or "DVD". If your stream is stored in a MPEG file (*.mpeg, *.mpg, *.vob, and so on...), it is probably in Mpeg1-PS or Mpeg2-PS format .
- if "type" is set to "Mpeg1-PS", "Mpeg2-PS", or "Mpeg2-TS", VLS will assume your stream is stored in the file "file", in the directory "path" ("path" being the variable defined in the "Input" section) .
- if "type" is "DVD", the variable "Device" will be used instead of "FileName" (the variable "FilesPath" is not prepended to the device name !). The variable "Device" is the device of your DVD drive ("/dev/hdc" or "/dev/cdrom" for instance). You can also play a DVD copied on a hard disk: then "device" is the directory where the .vob files are stored ("/mnt/data/VIDEO_TS" for instance) .

 VLS can stream MPEG files that meet two criteria :

VLS user guide

- the file must be MPEG *PS* (Program Stream) or MPEG *TS* (Transport Stream), that contain video and audio multiplexed. VLS cannot stream MPEG *ES* (Elementary Stream), i.e. a file with only audio or video .

In order to know if an MPEG file is MPEG *PS*, MPEG *TS* or MPEG *ES*, read the file with VLC and look at the messages (select in the menu *View / Messages*, or use the command line `vlc -vvv`) .

- ◆ If you see a line :

```
[00000107] main module debug: using demux module "ts_dvbpsi"
```

it means the file is MPEG *TS* .

- ◆ If you see a line :

```
[00000109] main module debug: using demux module "ps"
```

it means the file is MPEG *PS* .

- ◆ If you see a line :

```
[00000109] main module debug: using demux module "es"
```

it means the file is MPEG *ES*, VLS can't stream it. .

- the sequence header of the video must repeat itself regularly, which is often the case with MPEG-2, but very rare with MPEG-1. There is no easy way to know if the sequence header is repeated regularly. Files with a *.vob* extension are normally MPEG-2 files and files with *.mpg* or *.mpeg* extension or usually MPEG-1 files .

You can download this streamable MPEG-2 PS file for your tests : [presentation_short.vob](#) .



In order to play DVDs, you need to compile VLS with DVD support, which uses `libdvdread` and `libdvdcss`. You will need read *and* write access rights to the DVD device .

Full example :

```
BEGIN "Input"
  FilePath = "/home/videolan/streams"
  ProgramCount = "4"
END

BEGIN "1"      # MPEG2 stream stored in /home/videolan/streams/Dolby.vob
  Name       = "dolby"
  FileName   = "Dolby.vob"
  Type       = "Mpeg2-PS"
END

BEGIN "2"      # another file
  Name       = "canyon"
  FileName   = "Dolby_Canyon.vob"
  Type       = "Mpeg2-PS"
END

BEGIN "3"      # DVD
  Name       = "dvd"
  Device     = "/dev/cdrom"
  Type       = "Dvd"
END

BEGIN "4"      # DVD stored on a hard disk
  Name       = "matrix"
  Device     = "/mnt/data/matrix/VIDEO_TS"
```

```
Type      = "Dvd"  
END
```

Chapter 5. Running VLS

5.1. Launching VLS

If you want to use the telnet interface, running VLS is very easy: just type `vls` in a shell console, and that's all. Running `vlsd` will start VLS as a daemon and will detach itself from the launching shell. Remember that VLS will try to load its configuration file (`vls.cfg`) from the current directory, and if there is no `vls.cfg` there, it will try to load it from `SYSCONF_DIR/etc/videolan` (see section [Configuration](#)).

 If your log file is `vls.log` as in the example, VLS will need write access in the current directory, or you will see something like :

```
*** Exception *** in copy constructor (0xbffffc98, copy of 0x80e30a8)
Unable to open the log file "vls.log": Error: Could not open file 'vls.log':
Permission denied
```

Remember also that you must be root when using the "Interface" option in `vls.cfg`.

If everything is right, you will see something like :

```
VideoLAN Server v 0.5.3 (Jun 6 2003) - (c)1999-2003 VideoLAN
2002-03-09 17:24:51 [INFO/Vls] Module "channel:file" registered
2002-03-09 17:24:51 [INFO/Vls] Module "channel:network" registered
2002-03-09 17:24:51 [INFO/Vls] Module "mpegreader:file" registered
2002-03-09 17:24:51 [INFO/Vls] Module "mpegconverter:ts2ts" registered
[...]
```

What you can see on the screen (stderr) is exactly what goes in the log file `vls.log`.

When VLS has been successfully started, it doesn't take any command from its standard input, so you can put it into background (you can use the *screen* utility to do that).

On the other hand, if you want to use the command line interface, please see the [VideoLAN HOWTO](#).

5.2. Using the telnet interface

After VLS has been launched, it opens a telnet server (on the port 9999 by default). You can connect to this server with the following command :

```
% telnet localhost 9999
```

You should see something like :

```
Trying 127.0.0.1...
Connected to vls.
Escape character is '^]'.

Videolan Server Administration System

Login:
```

Then you must authenticate with a login/password pair defined in `vls.cfg`. When you have been successfully authenticated, you should see a prompt like :

```
admin@vls>  
>
```

Then you can type some commands, which are explained in the next paragraph. To log out, type **logout** after the telnet prompt .

5.3. Interface commands

5.3.1. help

Usage: help [command] .

Called with no argument, "help" gives the list of all the commands (available or not). Called with one argument it gives details about how to use the specified command .

5.3.2. browse

Usage: browse [input] .

Called without argument, "browse" gives all programs of inputs. Called with one argument it only gives the programs of the specified input. Each program is given with its status .

5.3.3. start

Usage: start <program> <channel> <input> [--loop] [--rtp]

"start" launches the specified program of the specified input and broadcasts it through the specified channel. The option "--loop" makes the program being repeated indefinitely. The option "--rtp" makes the TS packet to be send through the RTP protocol, as defined in RFC 1889 and RFC 2250 .

5.3.4. stop

Usage: stop <channel>

"stop" ends the broadcast of the specified channel .

5.3.5. forward

Usage: forward <channel> <speed>

"forward" forwards the channel with the given speed. This does not work when reading directly from a device such as an MPEG encoding card, a DVB card or an acquisition card .

5.3.6. rewind

Usage: rewind <channel> <speed>

"rewind" rewinds the channel with the given speed. This does not work when reading directly from a device such as an MPEG encoding card, a DVB card or an acquisition card .

5.3.7. suspend

Usage: suspend <channel>

"suspend" suspends the streaming of the specified channel .

5.3.8. resume

Usage: resume <channel>

"resume" resumes the streaming of the specified channel .

5.3.9. logout

Usage: logout

"logout" closes the current administration session and the remote connection .

5.3.10. shutdown

Usage: shutdown

"shutdown" stops all the programs and shutdowns VLS .

Appendix A. GNU Free Documentation License

Version 1.2, November 2002

Copyright (C) 2000,2001,2002 Free Software Foundation, Inc. 59 Temple Place, Suite 330, Boston, MA 02111-1307 USA Everyone is permitted to copy and distribute verbatim copies of this license document, but changing it is not allowed.

A.1. PREAMBLE

The purpose of this License is to make a manual, textbook, or other functional and useful document "free" in the sense of freedom: to assure everyone the effective freedom to copy and redistribute it, with or without modifying it, either commercially or noncommercially. Secondly, this License preserves for the author and publisher a way to get credit for their work, while not being considered responsible for modifications made by others.

This License is a kind of "copyleft", which means that derivative works of the document must themselves be free in the same sense. It complements the GNU General Public License, which is a copyleft license designed for free software.

We have designed this License in order to use it for manuals for free software, because free software needs free documentation: a free program should come with manuals providing the same freedoms that the software does. But this License is not limited to software manuals; it can be used for any textual work, regardless of subject matter or whether it is published as a printed book. We recommend this License principally for works whose purpose is instruction or reference.

A.2. APPLICABILITY AND DEFINITIONS

This License applies to any manual or other work, in any medium, that contains a notice placed by the copyright holder saying it can be distributed under the terms of this License. Such a notice grants a world-wide, royalty-free license, unlimited in duration, to use that work under the conditions stated herein. The "Document", below, refers to any such manual or work. Any member of the public is a licensee, and is addressed as "you". You accept the license if you copy, modify or distribute the work in a way requiring permission under copyright law.

A "Modified Version" of the Document means any work containing the Document or a portion of it, either copied verbatim, or with modifications and/or translated into another language.

A "Secondary Section" is a named appendix or a front-matter section of the Document that deals exclusively with the relationship of the publishers or authors of the Document to the Document's overall subject (or to related matters) and contains nothing that could fall directly within that overall subject. (Thus, if the Document is in part a textbook of mathematics, a Secondary Section may not explain any mathematics.) The relationship could be a matter of historical connection with the subject or with related matters, or of legal, commercial, philosophical, ethical or political position regarding them.

The "Invariant Sections" are certain Secondary Sections whose titles are designated, as being those of Invariant Sections, in the notice that says that the Document is released under this License. If a section does not fit the above definition of Secondary then it is not allowed to be designated as Invariant. The Document

may contain zero Invariant Sections. If the Document does not identify any Invariant Sections then there are none.

The "Cover Texts" are certain short passages of text that are listed, as Front–Cover Texts or Back–Cover Texts, in the notice that says that the Document is released under this License. A Front–Cover Text may be at most 5 words, and a Back–Cover Text may be at most 25 words.

A "Transparent" copy of the Document means a machine–readable copy, represented in a format whose specification is available to the general public, that is suitable for revising the document straightforwardly with generic text editors or (for images composed of pixels) generic paint programs or (for drawings) some widely available drawing editor, and that is suitable for input to text formatters or for automatic translation to a variety of formats suitable for input to text formatters. A copy made in an otherwise Transparent file format whose markup, or absence of markup, has been arranged to thwart or discourage subsequent modification by readers is not Transparent. An image format is not Transparent if used for any substantial amount of text. A copy that is not "Transparent" is called "Opaque".

Examples of suitable formats for Transparent copies include plain ASCII without markup, Texinfo input format, LaTeX input format, SGML or XML using a publicly available DTD, and standard–conforming simple HTML, PostScript or PDF designed for human modification. Examples of transparent image formats include PNG, XCF and JPG. Opaque formats include proprietary formats that can be read and edited only by proprietary word processors, SGML or XML for which the DTD and/or processing tools are not generally available, and the machine–generated HTML, PostScript or PDF produced by some word processors for output purposes only.

The "Title Page" means, for a printed book, the title page itself, plus such following pages as are needed to hold, legibly, the material this License requires to appear in the title page. For works in formats which do not have any title page as such, "Title Page" means the text near the most prominent appearance of the work's title, preceding the beginning of the body of the text.

A section "Entitled XYZ" means a named subunit of the Document whose title either is precisely XYZ or contains XYZ in parentheses following text that translates XYZ in another language. (Here XYZ stands for a specific section name mentioned below, such as "Acknowledgements", "Dedications", "Endorsements", or "History".) To "Preserve the Title" of such a section when you modify the Document means that it remains a section "Entitled XYZ" according to this definition.

The Document may include Warranty Disclaimers next to the notice which states that this License applies to the Document. These Warranty Disclaimers are considered to be included by reference in this License, but only as regards disclaiming warranties: any other implication that these Warranty Disclaimers may have is void and has no effect on the meaning of this License.

A.3. VERBATIM COPYING

You may copy and distribute the Document in any medium, either commercially or noncommercially, provided that this License, the copyright notices, and the license notice saying this License applies to the Document are reproduced in all copies, and that you add no other conditions whatsoever to those of this License. You may not use technical measures to obstruct or control the reading or further copying of the copies you make or distribute. However, you may accept compensation in exchange for copies. If you distribute a large enough number of copies you must also follow the conditions in section 3.

You may also lend copies, under the same conditions stated above, and you may publicly display copies.

A.4. COPYING IN QUANTITY

If you publish printed copies (or copies in media that commonly have printed covers) of the Document, numbering more than 100, and the Document's license notice requires Cover Texts, you must enclose the copies in covers that carry, clearly and legibly, all these Cover Texts: Front–Cover Texts on the front cover, and Back–Cover Texts on the back cover. Both covers must also clearly and legibly identify you as the publisher of these copies. The front cover must present the full title with all words of the title equally prominent and visible. You may add other material on the covers in addition. Copying with changes limited to the covers, as long as they preserve the title of the Document and satisfy these conditions, can be treated as verbatim copying in other respects.

If the required texts for either cover are too voluminous to fit legibly, you should put the first ones listed (as many as fit reasonably) on the actual cover, and continue the rest onto adjacent pages.

If you publish or distribute Opaque copies of the Document numbering more than 100, you must either include a machine–readable Transparent copy along with each Opaque copy, or state in or with each Opaque copy a computer–network location from which the general network–using public has access to download using public–standard network protocols a complete Transparent copy of the Document, free of added material. If you use the latter option, you must take reasonably prudent steps, when you begin distribution of Opaque copies in quantity, to ensure that this Transparent copy will remain thus accessible at the stated location until at least one year after the last time you distribute an Opaque copy (directly or through your agents or retailers) of that edition to the public.

It is requested, but not required, that you contact the authors of the Document well before redistributing any large number of copies, to give them a chance to provide you with an updated version of the Document.

A.5. MODIFICATIONS

You may copy and distribute a Modified Version of the Document under the conditions of sections 2 and 3 above, provided that you release the Modified Version under precisely this License, with the Modified Version filling the role of the Document, thus licensing distribution and modification of the Modified Version to whoever possesses a copy of it. In addition, you must do these things in the Modified Version:

- A. Use in the Title Page (and on the covers, if any) a title distinct from that of the Document, and from those of previous versions (which should, if there were any, be listed in the History section of the Document). You may use the same title as a previous version if the original publisher of that version gives permission.
- B. List on the Title Page, as authors, one or more persons or entities responsible for authorship of the modifications in the Modified Version, together with at least five of the principal authors of the Document (all of its principal authors, if it has fewer than five), unless they release you from this requirement.
- C. State on the Title page the name of the publisher of the Modified Version, as the publisher.
- D. Preserve all the copyright notices of the Document.
- E. Add an appropriate copyright notice for your modifications adjacent to the other copyright notices.
- F. Include, immediately after the copyright notices, a license notice giving the public permission to use the Modified Version under the terms of this License, in the form shown in the [Addendum](#) below.
- G. Preserve in that license notice the full lists of Invariant Sections and required Cover Texts given in the Document's license notice.

- H. Include an unaltered copy of this License.
- I. Preserve the section Entitled "History", Preserve its Title, and add to it an item stating at least the title, year, new authors, and publisher of the Modified Version as given on the Title Page. If there is no section Entitled "History" in the Document, create one stating the title, year, authors, and publisher of the Document as given on its Title Page, then add an item describing the Modified Version as stated in the previous sentence.
- J. Preserve the network location, if any, given in the Document for public access to a Transparent copy of the Document, and likewise the network locations given in the Document for previous versions it was based on. These may be placed in the "History" section. You may omit a network location for a work that was published at least four years before the Document itself, or if the original publisher of the version it refers to gives permission.
- K. For any section Entitled "Acknowledgements" or "Dedications", Preserve the Title of the section, and preserve in the section all the substance and tone of each of the contributor acknowledgements and/or dedications given therein.
- L. Preserve all the Invariant Sections of the Document, unaltered in their text and in their titles. Section numbers or the equivalent are not considered part of the section titles.
- M. Delete any section Entitled "Endorsements". Such a section may not be included in the Modified Version.
- N. Do not retitle any existing section to be Entitled "Endorsements" or to conflict in title with any Invariant Section.
- O. Preserve any Warranty Disclaimers.

If the Modified Version includes new front-matter sections or appendices that qualify as Secondary Sections and contain no material copied from the Document, you may at your option designate some or all of these sections as invariant. To do this, add their titles to the list of Invariant Sections in the Modified Version's license notice. These titles must be distinct from any other section titles.

You may add a section Entitled "Endorsements", provided it contains nothing but endorsements of your Modified Version by various parties—for example, statements of peer review or that the text has been approved by an organization as the authoritative definition of a standard.

You may add a passage of up to five words as a Front-Cover Text, and a passage of up to 25 words as a Back-Cover Text, to the end of the list of Cover Texts in the Modified Version. Only one passage of Front-Cover Text and one of Back-Cover Text may be added by (or through arrangements made by) any one entity. If the Document already includes a cover text for the same cover, previously added by you or by arrangement made by the same entity you are acting on behalf of, you may not add another; but you may replace the old one, on explicit permission from the previous publisher that added the old one.

The author(s) and publisher(s) of the Document do not by this License give permission to use their names for publicity for or to assert or imply endorsement of any Modified Version.

A.6. COMBINING DOCUMENTS

You may combine the Document with other documents released under this License, under the terms defined in [section 4](#) above for modified versions, provided that you include in the combination all of the Invariant Sections of all of the original documents, unmodified, and list them all as Invariant Sections of your combined work in its license notice, and that you preserve all their Warranty Disclaimers.

The combined work need only contain one copy of this License, and multiple identical Invariant Sections may be replaced with a single copy. If there are multiple Invariant Sections with the same name but different

contents, make the title of each such section unique by adding at the end of it, in parentheses, the name of the original author or publisher of that section if known, or else a unique number. Make the same adjustment to the section titles in the list of Invariant Sections in the license notice of the combined work.

In the combination, you must combine any sections Entitled "History" in the various original documents, forming one section Entitled "History"; likewise combine any sections Entitled "Acknowledgements", and any sections Entitled "Dedications". You must delete all sections Entitled "Endorsements".

A.7. COLLECTIONS OF DOCUMENTS

You may make a collection consisting of the Document and other documents released under this License, and replace the individual copies of this License in the various documents with a single copy that is included in the collection, provided that you follow the rules of this License for verbatim copying of each of the documents in all other respects.

You may extract a single document from such a collection, and distribute it individually under this License, provided you insert a copy of this License into the extracted document, and follow this License in all other respects regarding verbatim copying of that document.

A.8. AGGREGATION WITH INDEPENDENT WORKS

A compilation of the Document or its derivatives with other separate and independent documents or works, in or on a volume of a storage or distribution medium, is called an "aggregate" if the copyright resulting from the compilation is not used to limit the legal rights of the compilation's users beyond what the individual works permit. When the Document is included in an aggregate, this License does not apply to the other works in the aggregate which are not themselves derivative works of the Document.

If the Cover Text requirement of section 3 is applicable to these copies of the Document, then if the Document is less than one half of the entire aggregate, the Document's Cover Texts may be placed on covers that bracket the Document within the aggregate, or the electronic equivalent of covers if the Document is in electronic form. Otherwise they must appear on printed covers that bracket the whole aggregate.

A.9. TRANSLATION

Translation is considered a kind of modification, so you may distribute translations of the Document under the terms of section 4. Replacing Invariant Sections with translations requires special permission from their copyright holders, but you may include translations of some or all Invariant Sections in addition to the original versions of these Invariant Sections. You may include a translation of this License, and all the license notices in the Document, and any Warranty Disclaimers, provided that you also include the original English version of this License and the original versions of those notices and disclaimers. In case of a disagreement between the translation and the original version of this License or a notice or disclaimer, the original version will prevail.

If a section in the Document is Entitled "Acknowledgements", "Dedications", or "History", the requirement (section 4) to Preserve its Title (section 1) will typically require changing the actual title.

A.10. TERMINATION

You may not copy, modify, sublicense, or distribute the Document except as expressly provided for under this License. Any other attempt to copy, modify, sublicense or distribute the Document is void, and will automatically terminate your rights under this License. However, parties who have received copies, or rights, from you under this License will not have their licenses terminated so long as such parties remain in full compliance.

A.11. FUTURE REVISIONS OF THIS LICENSE

The Free Software Foundation may publish new, revised versions of the GNU Free Documentation License from time to time. Such new versions will be similar in spirit to the present version, but may differ in detail to address new problems or concerns. See <http://www.gnu.org/copyleft/>.

Each version of the License is given a distinguishing version number. If the Document specifies that a particular numbered version of this License "or any later version" applies to it, you have the option of following the terms and conditions either of that specified version or of any later version that has been published (not as a draft) by the Free Software Foundation. If the Document does not specify a version number of this License, you may choose any version ever published (not as a draft) by the Free Software Foundation.

A.12. ADDENDUM: How to use this License for your documents

To use this License in a document you have written, include a copy of the License in the document and put the following copyright and license notices just after the title page:

Copyright (c) YEAR YOUR NAME. Permission is granted to copy, distribute and/or modify this document under the terms of the GNU Free Documentation License, Version 1.2 or any later version published by the Free Software Foundation; with no Invariant Sections, no Front-Cover Texts, and no Back-Cover Texts. A copy of the license is included in the section entitled "GNU Free Documentation License".

If you have Invariant Sections, Front-Cover Texts and Back-Cover Texts, replace the "with...Texts." line with this:

with the Invariant Sections being LIST THEIR TITLES, with the Front-Cover Texts being LIST, and with the Back-Cover Texts being LIST.

If you have Invariant Sections without Cover Texts, or some other combination of the three, merge those two alternatives to suit the situation.

If your document contains nontrivial examples of program code, we recommend releasing these examples in parallel under your choice of free software license, such as the GNU General Public License, to permit their use in free software.